

Hall B of Jefferson Lab: Highlights

Dr. Sebouh J. Paul
UC Riverside
4/5/2024

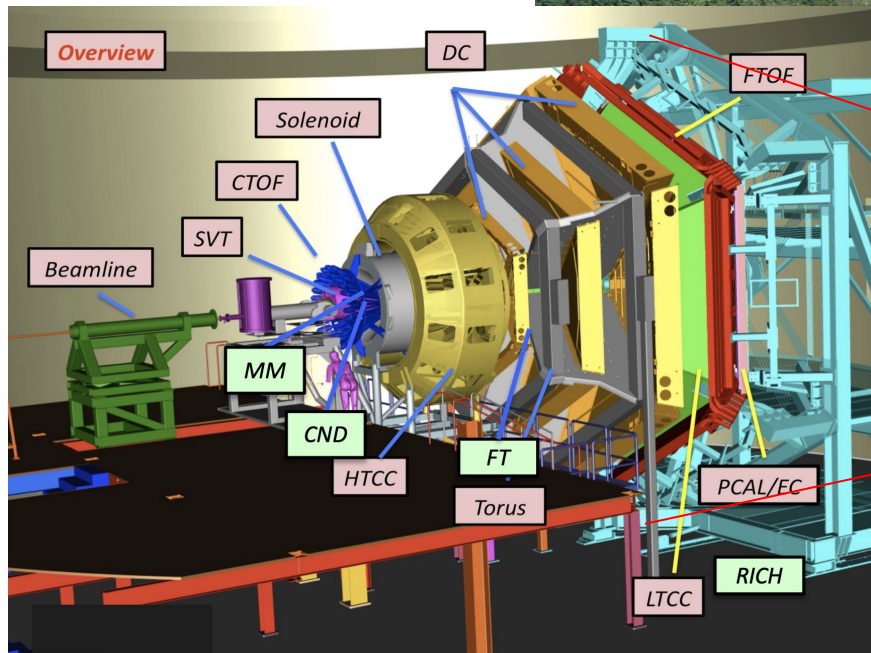

CLAS12 at Hall B

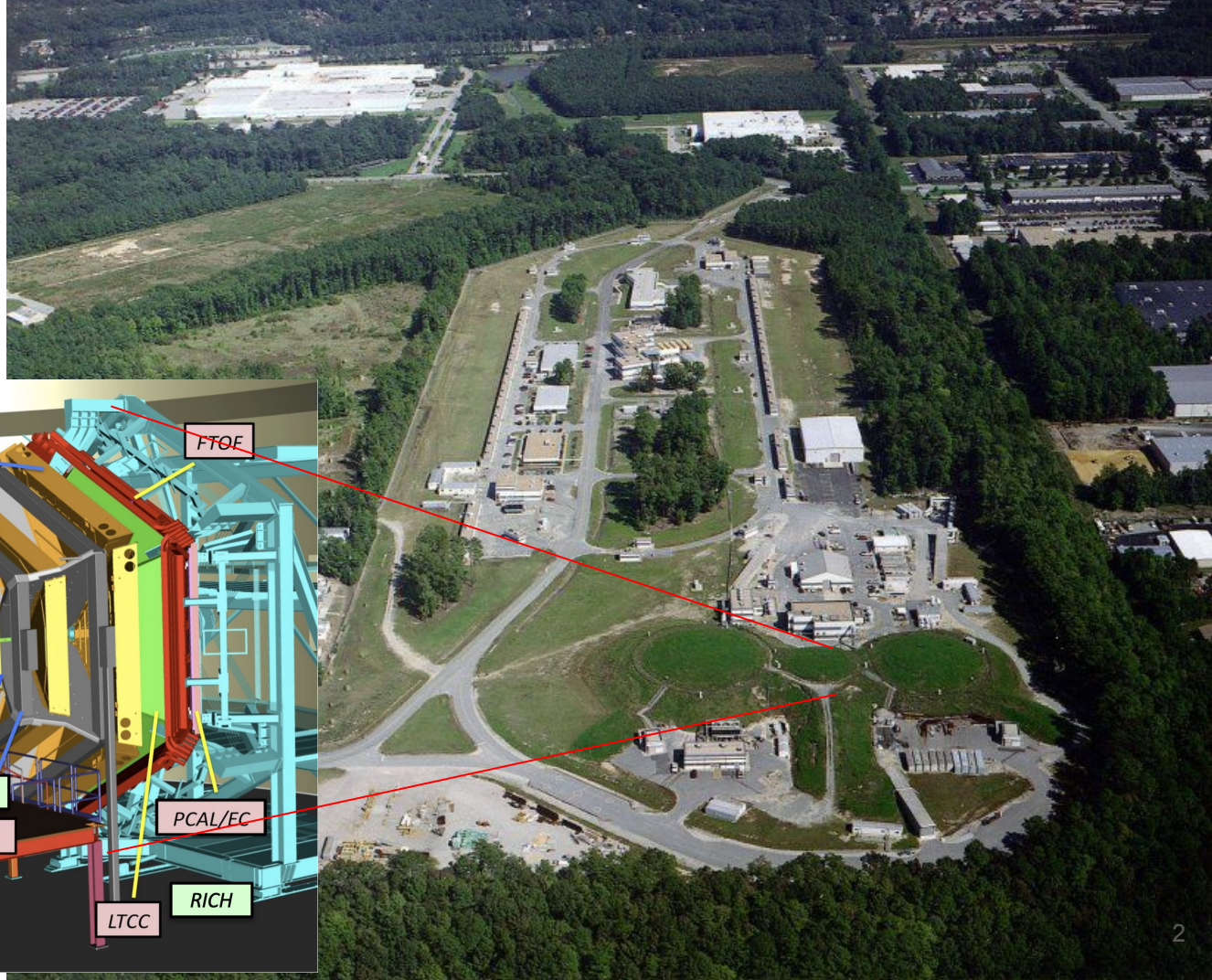

Recent data taken (Run Groups D and K)

Run Group D (Oct-Dec 2023)

Setup:

- 10.54 GeV e- beam on LD2, two-foil carbon target, or Cu/Sn double target.

Proposals:

- Study of Color Transparency (CT) in Exclusive Vector Meson Electroproduction off Nuclei (E12-06-106A)
 - W. Armstrong , L. El Fassi , K. Hafidi , M. Holtrop , and B. Mustapha
- Nuclear TMDs in CLAS12 (E12-06-106)
 - R. Dupré, L. El Fassi, Zein-Eddine Meziani, and Holly Szumila-Vance

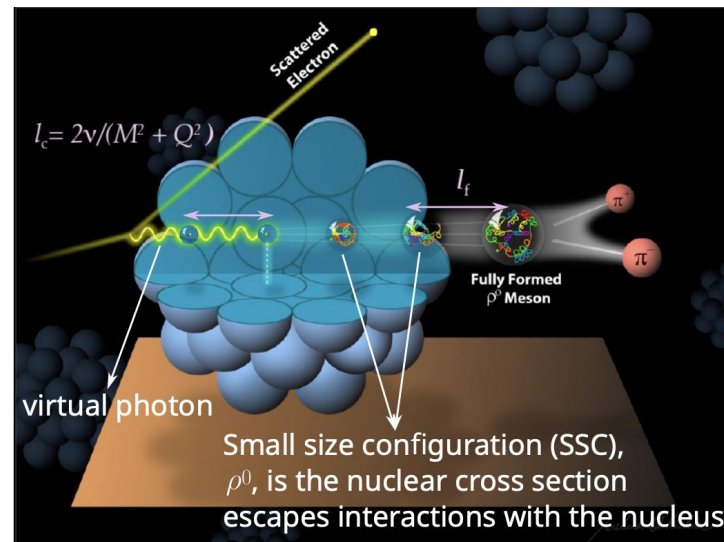
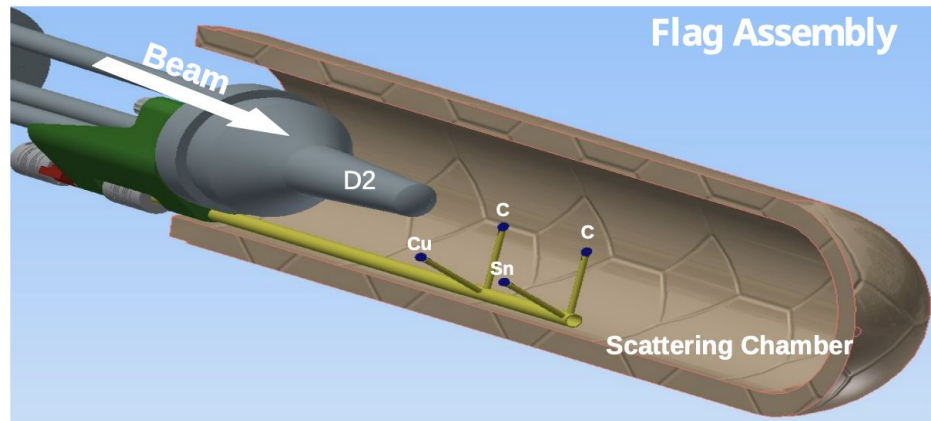

Run Group K (Dec. 2023-Mar 2024)

Setup:

- 6.4 and 8.5 GeV electron beam on LH2 target

Multiple proposals:

- A Search for Hybrid Baryons in Hall B with CLAS12
 - E12-16-010 – Annalisa D'Angelo
- Nucleon Resonance Structure Studies Via Exclusive KY Electroproduction at 6.6 GeV and 8.8 GeV
 - E12-16-010A – Daniel Carman
- Deeply Virtual Compton Scattering with CLAS12 at 6.6 GeV and 8.8 GeV
 - E12-16-010B — Latifa Elouadrhiri
- Separation of the σ_L and σ_T contributions to the production of hadrons in electroproduction
 - E12-16-010C– Tim Hayward, Harut Avakian

Highly successful Spring 2024 run period:

- Quadrupled available RG-K data (compared to Fall 2018 dataset).

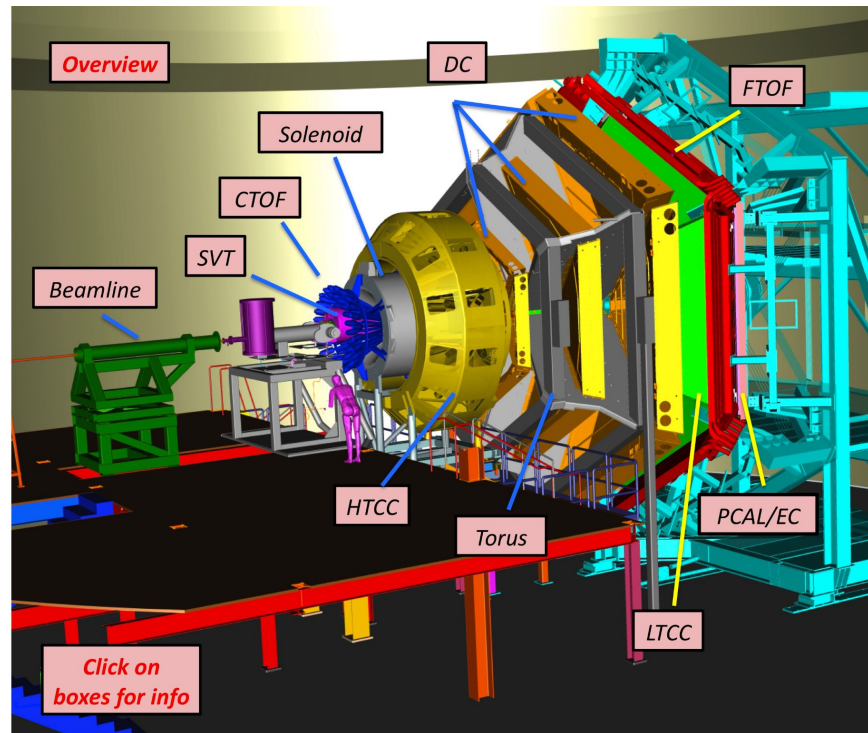

Recent Publications and Analyses

Double-pion electroproduction off protons in deuterium: quasi-free cross sections and final state interactions*

$$\gamma^* p(n) \rightarrow p'(n') \pi^+ \pi^-$$

- Cross sections $\sigma_{\gamma^* d}$
- Ratio $\sigma_{\gamma^* d} / \sigma_{\gamma^* p}^{\text{calc}}$ investigates the effect of final-state interactions
- Results were given multi-dimensionally.

Iu. A. Skorodumina et al, (CLAS Collab)

[arXiv:2308.13962](https://arxiv.org/abs/2308.13962), to be published in Phys. Rev. C

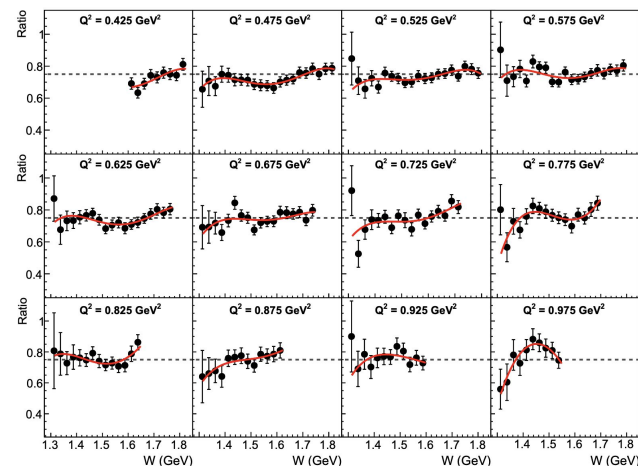
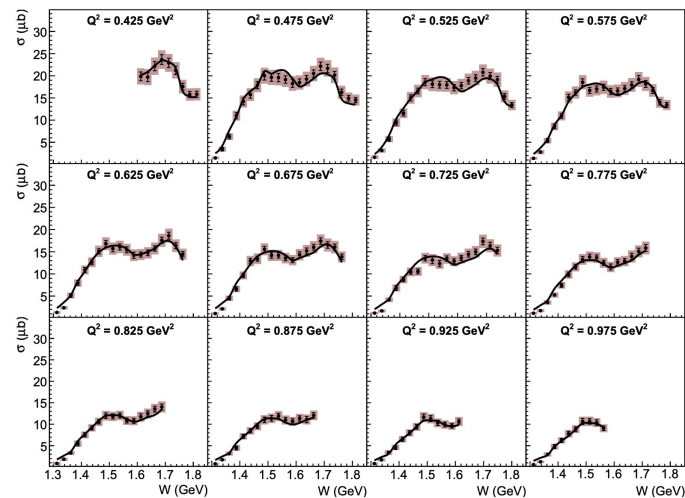

FIG. 16. Ratio of the fully integrated quasi-free cross sections obtained in this study over the free proton cross sections from Refs. [17, 18]. The red curves correspond to the polynomial fit. The dashed line marks the value of 0.75.

Recent publication: Beam spin asymmetry measurements of deeply virtual π^0 production with CLAS12

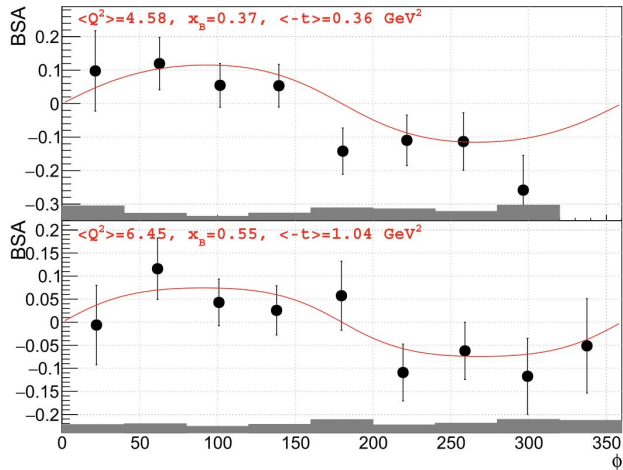

Fig. 5. Beam spin asymmetry as a function of ϕ for two representative kinematic bins. The vertical error bars show the statistical uncertainty of each point. The gray bands represent systematic uncertainties of the BSA measurements. The red lines show the fit with functional form of Eq. (1).

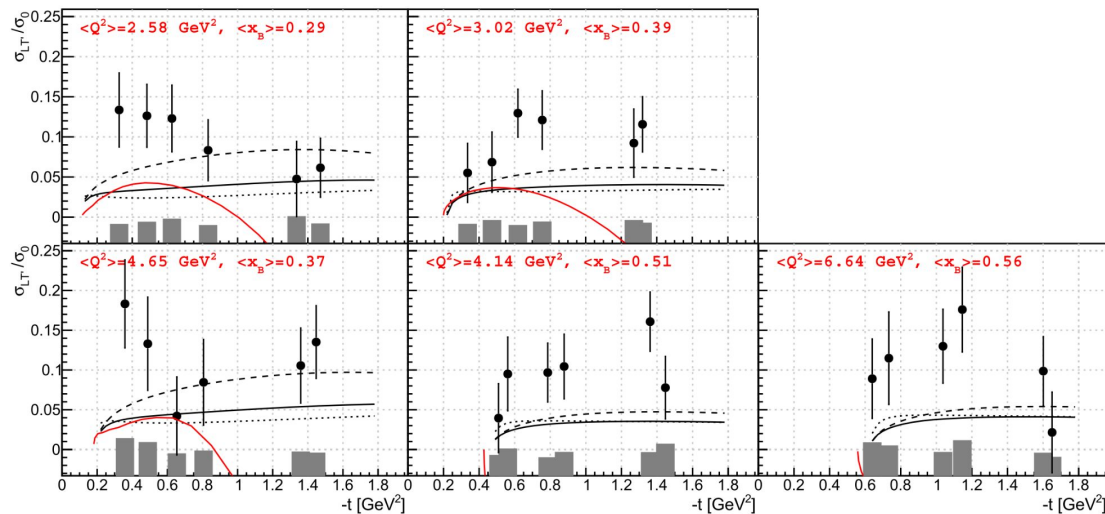
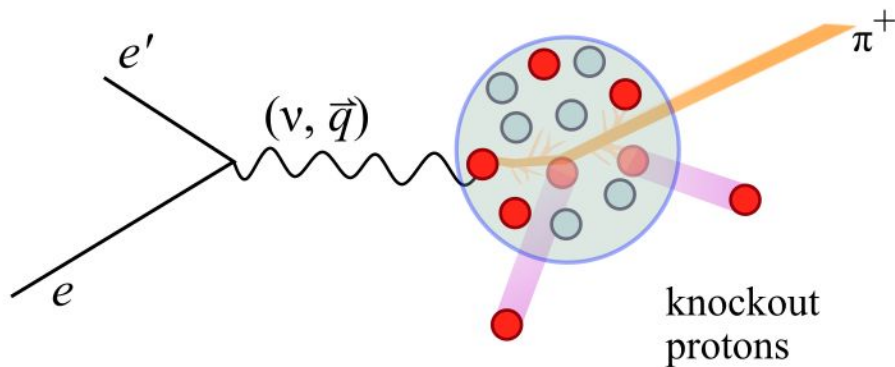
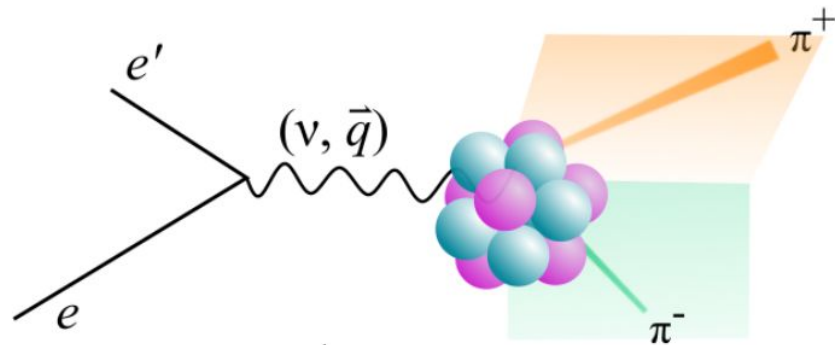

Fig. 6. The measurements of σ_{LT}/σ_0 and its statistical uncertainty as a function of $-t$ in the forward kinematic regime. The gray bins represent the systematic uncertainties. The black curves show the theoretical prediction from the GPD-based Goloskokov-Kroll model. The black dashed lines show the effect of the GPD \bar{E}_T multiplied by a factor of 0.5, and the black dotted lines show the effect of the GPD H_T multiplied by a factor of 0.5. The red curve shows the theoretical predictions from the Regge-based JML model.

Di-hadron analyses

- Recently published analyses on di-pion CLAS6 data highlighted in 2023 LRP
- “How are the various hadrons produced in a scattering process correlated with one another and how does hadronization change in a dense partonic environment?”
 - $\pi^+\pi^-$ analysis in ad-hoc (internal) review
 - π^+p analysis note currently on-going



Software Developments

Iguana

- Implementation **Guardian of Analysis Algorithms**
 - Author: Christopher Dilks
- Algorithms produce new banks in HIPO format or modify existing ones
- Algorithms include common tasks such as
 - Energy-loss corrections
 - Fiducial cuts
 - Other particle-selection/event-selection cuts
- Iguana allows such common algorithms to be stored in a centralized repository



<https://github.com/JeffersonLab/iguana>

Online-reconstruction: conventional and machine learning

- Conventional recon allows realtime analysis with track recon, vertex positions, particle ID and missing mass distributions
- A machine-learning version of reconstruction is also being developed*, further improving the reconstruction speed.

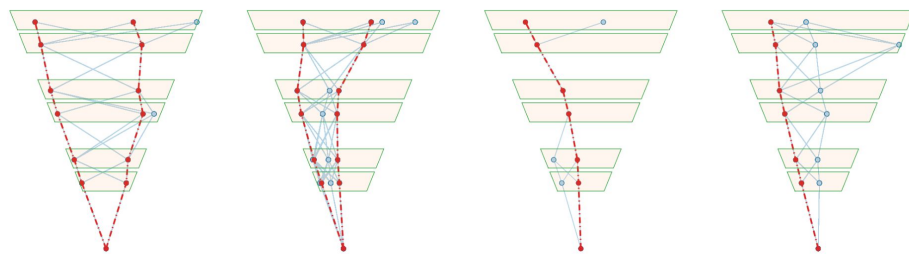
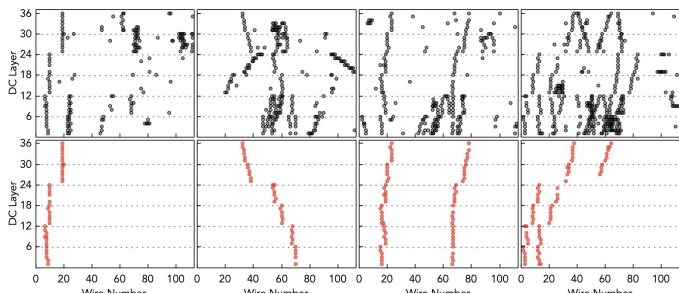

*"Real Time Charged Track Reconstruction for CLAS12"
Gagik Gavalian [arXiv:2403.04020](https://arxiv.org/abs/2403.04020), submitted to JINST

Ongoing and Upcoming Experiments

Run Group E (current experiment)

Deuterium and nuclear targets simultaneously exposed to electron beam to allow cancellation of systematic uncertainties in A/D ratios.

Extends CLAS6 EG2 measurements with

- Higher luminosity
- More target types
- Higher beam energy
- Polarized beam
 - Allows beam-spin asymmetries that can be compared to ep scattering

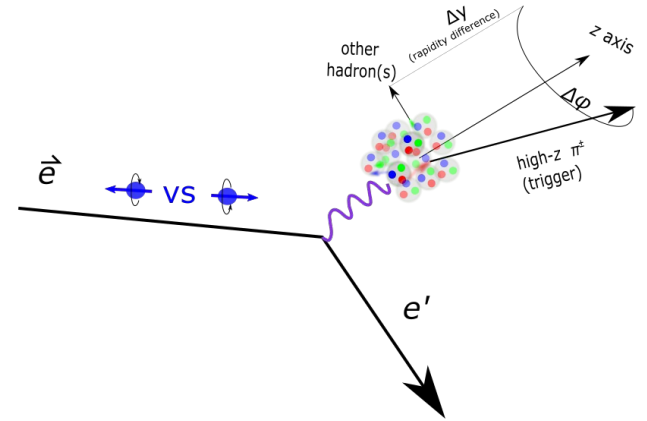

Double target system

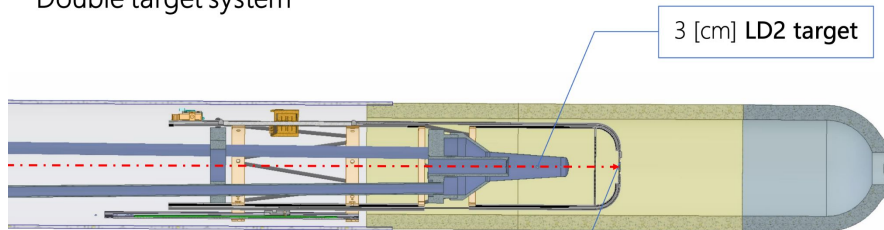

- Carbon (C-12)
- Aluminum (Al-27)
- Copper (Cu-63)
- Tin (Sn-120)
- Lead (Pb-208)

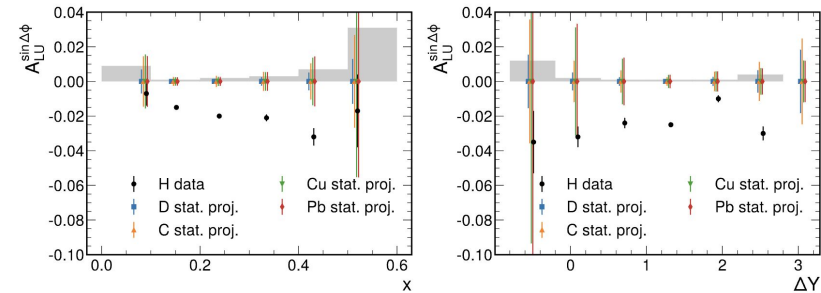

Upcoming experiment: Run Group L, with ALERT detector

- Hyperbolic drift chamber allowing measurements of particles with very low transverse momentum
 - low radius of curvature, and therefore close to the beamline
 - Example: tagged spectator p in scattering off n in deuterium
- Also includes TOF scintillators
- Planned start of run: October 2024

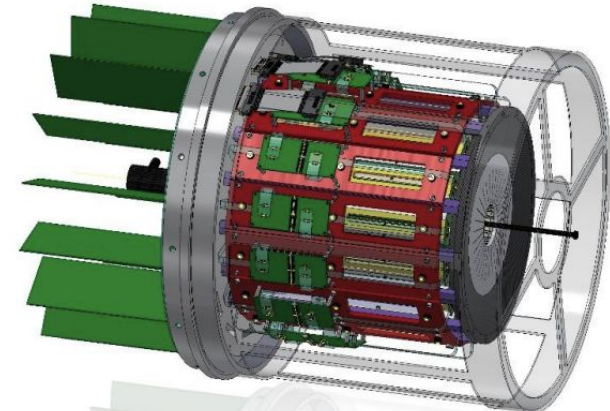
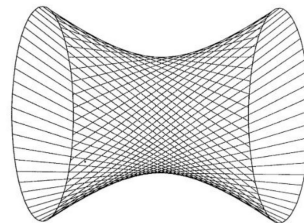
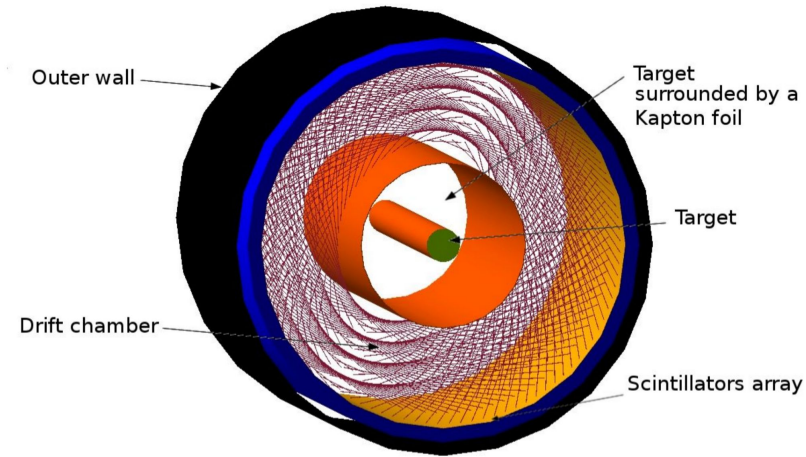

Upcoming experiment: Run Group L, with ALERT detector

Proposals:

- Partonic Structure of Light Nuclei
 - E12-17-012 (Z.E. Meziani)
- Tagged EMC measurements on Light Nuclei
 - E12-17-012A (R. Dupre)
- Spectator-Tagged DVCS on Light Nuclei
 - E12-17-012B (W. Armstrong)
- Other Physics Opportunities w/ ALERT
 - E12-17-012C (K. Hafidi)

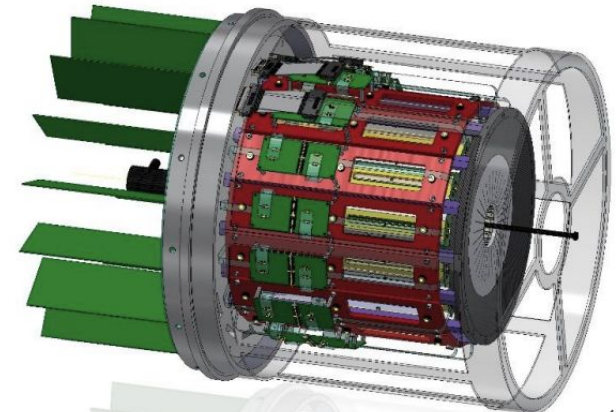
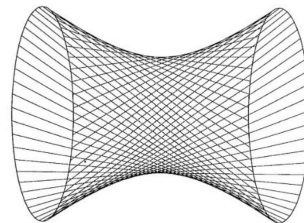
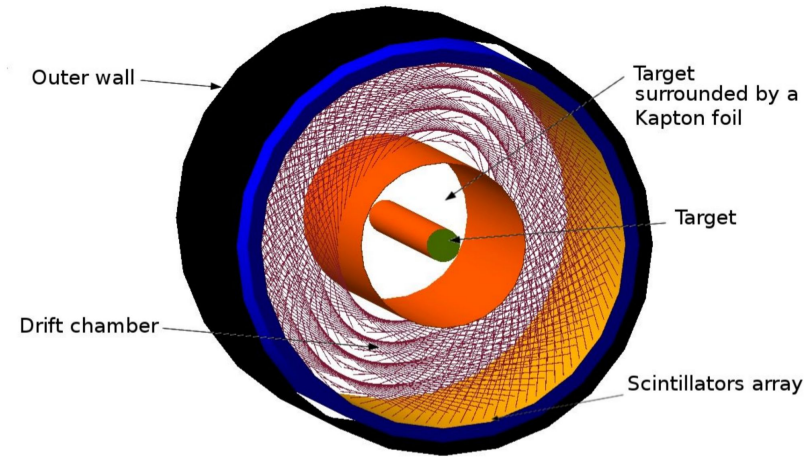

Possible future experiment: Open charm near threshold

- LOI being written to measure $ep \rightarrow e'\bar{D}^0\Lambda_c^+$ near threshold with CLAS12
- Two decay signatures:
 - $\bar{D}^0 \rightarrow K^+\pi^-$
 - $\Lambda_c^+ \rightarrow K^-\pi^+p$
- Signal overshadowed by background from other types of reactions in current setup
- Background could be reduced by requiring a displaced vertex:
 - Boosted lifetimes are $\sim 133 \mu\text{m}$ and $\sim 330 \mu\text{m}$ for \bar{D}^0 and Λ_c^+ respectively at $p \sim 5 \text{ GeV}$

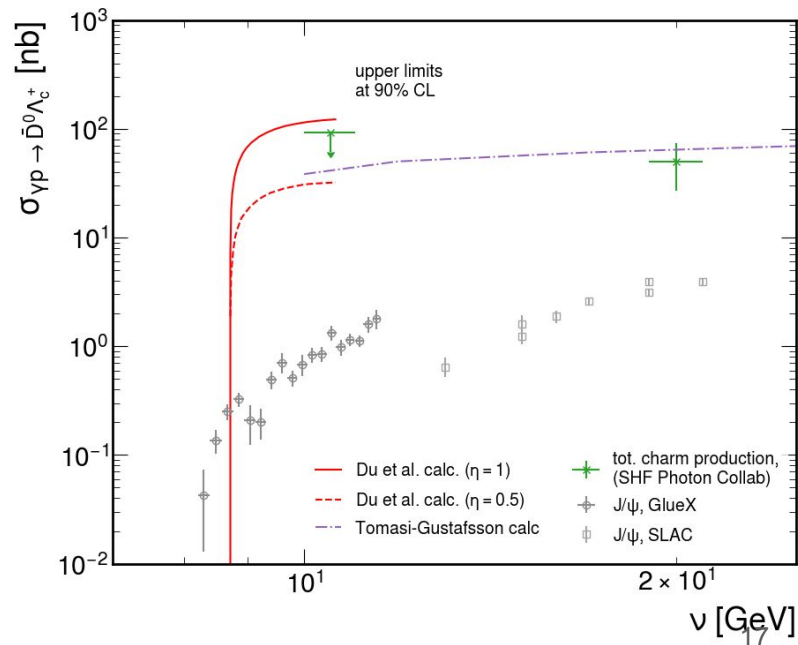
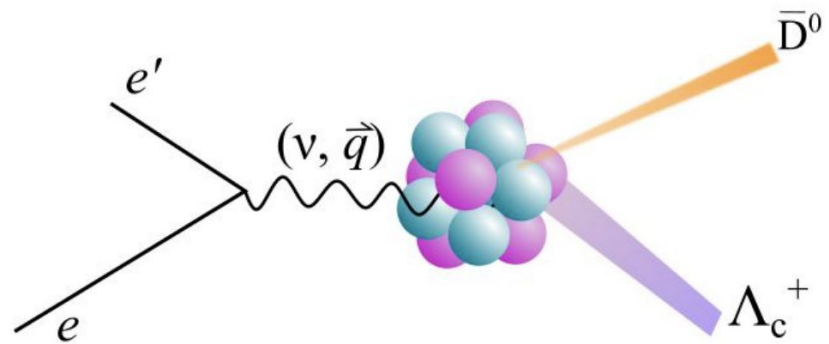

Open-Charm Production (continued)

- To improve the vertex resolution, we propose to borrow the MVTX detector from sPHENIX:
 - Pixel detector with pitch $27\ \mu\text{m}$
 - Vz resolution $\sim 5\ \mu\text{m}$
- Requiring one or more hadrons to have vertices $>3\sigma$ downstream of target could reduce background by several orders of magnitude.

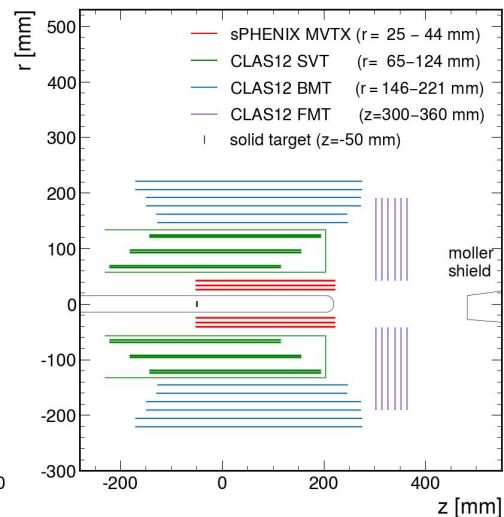
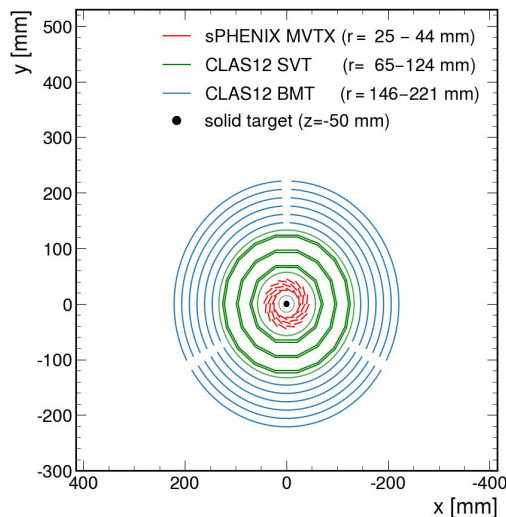
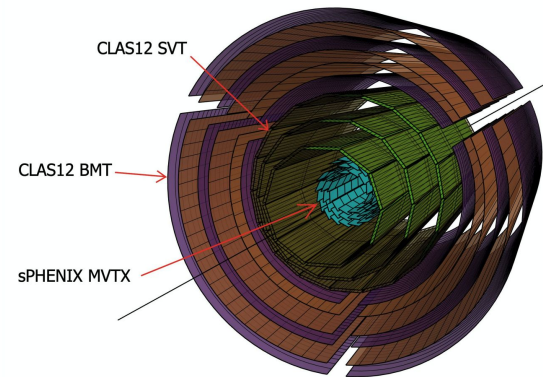
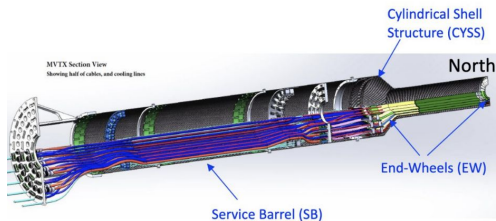

Summary

- We have had successful run periods with RGK and RGD
- Recent publications/accepted-for-publications
- Ongoing RGE experiment takes data with dual deuterium/nuclear target
- Upcoming ALERT experiment with RGL
- Letter of intent being drafted for future experiment with MVTX.