

PR-12-18-002

***Strange Hadron Spectroscopy with
Secondary K_L Beam at GlueX***

I. The K_L Facility at GlueX: Challenges and Feasibility

Moskov Amaryan

(For KLF Collaboration)

PAC46, July 17, 2018

Outline

Physics Motivation

- *Hyperon Spectroscopy (more from Mark Manley)*
- *Strange Meson Spectroscopy (more from Jose Pelaez)*

K_L Facility at JLab

- *Electron Beam*
- *Compact Photon Source*
- *Be Target*
- *Flux Monitor*
- *K_L Beam*
- *LH_2/LD_2 Target*

Summary

Hyperon Spectroscopy

According *LQCD* there should be many more states including hybrids (thick bordered)

8-states

5-states

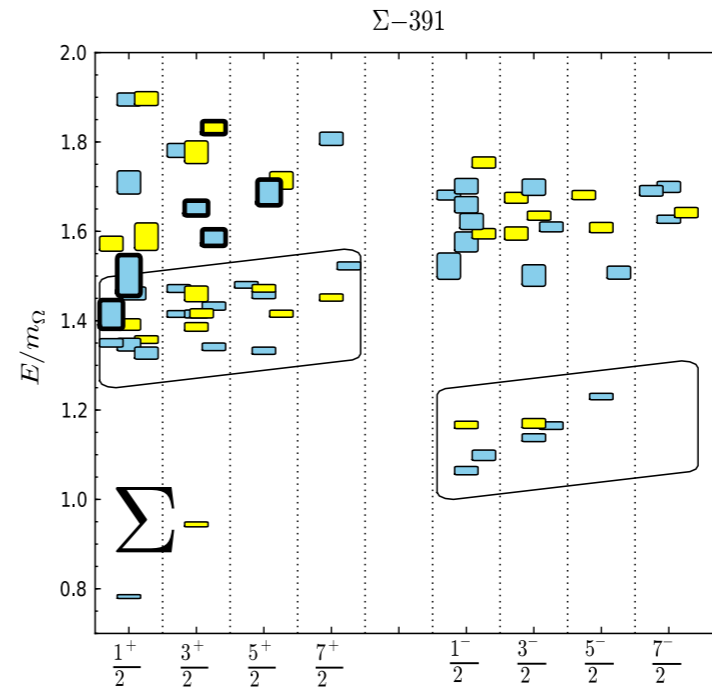
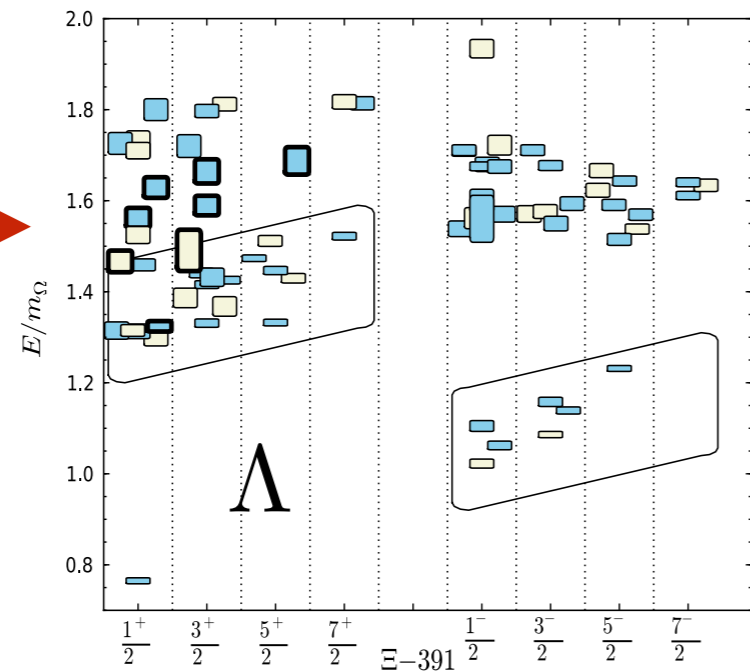

6-states

4-states

3-states

4-states

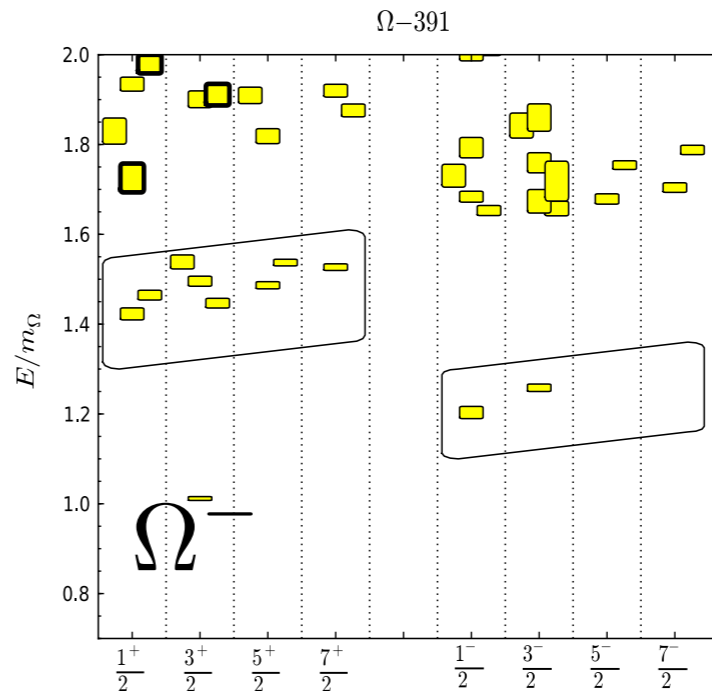
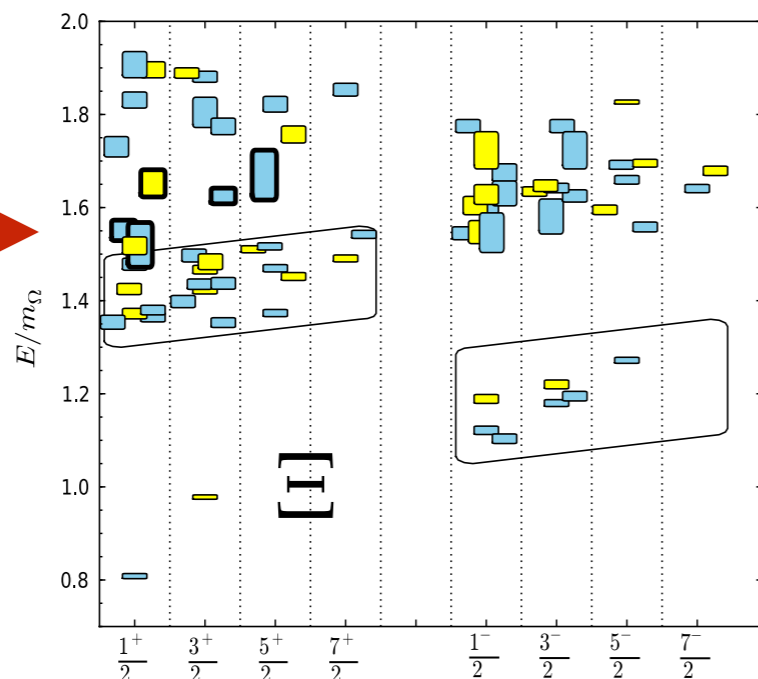

1-state

1-state

Edwards, Mathur, Richards and Wallace, Phys. Rev. D 87, 054506 (2013)

Proposed Measurements on Proton Target

existing data

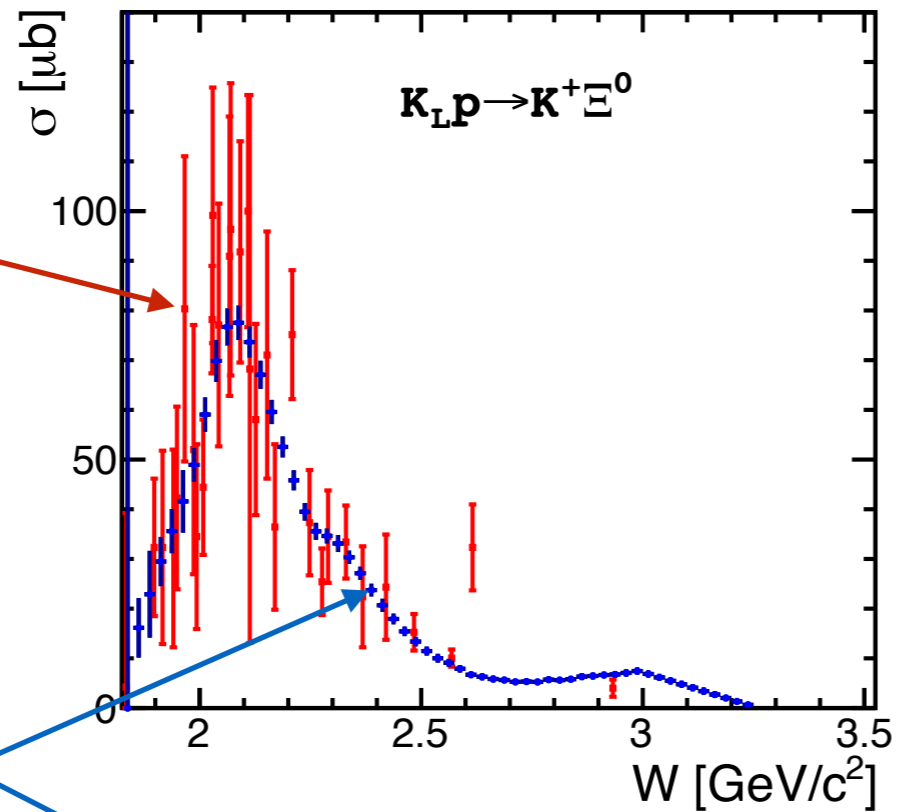

KLF 100 days

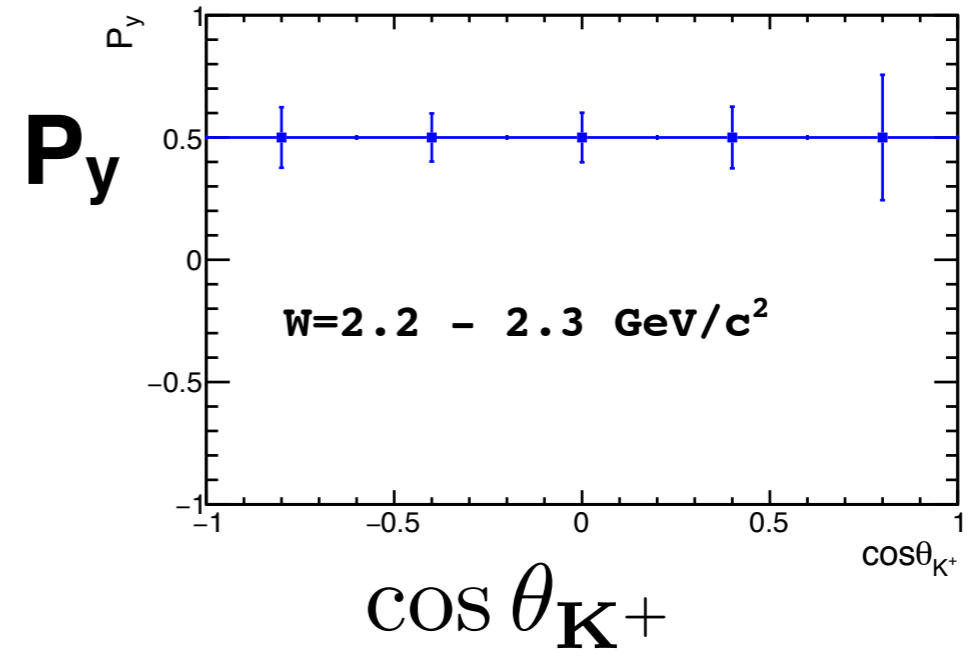
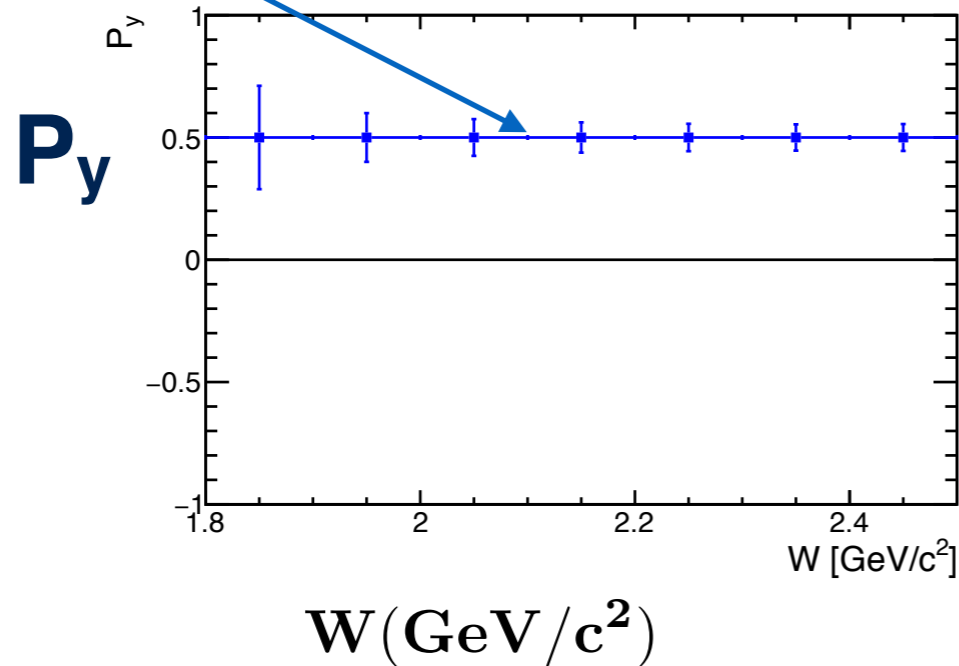
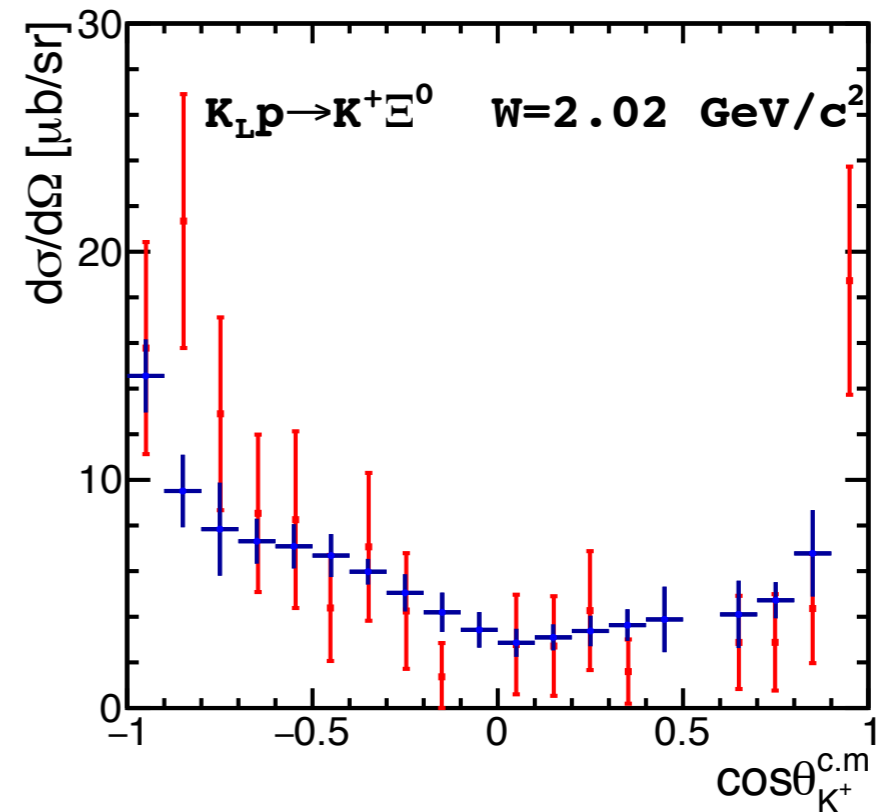

Search for Hyperon Resonances with PWA

For Scattering experiments on both proton & neutron targets we need to determine:

- differential cross sections &**
- self polarization of strange hyperons**
- perform coupled-channel PWA**
- look for poles in complex energy plane
(not naïve bump hunting)**
- identify Λ^* , Σ^* , Ξ^* & Ω^* up to 2400 MeV**

As kaon nucleon scattering data are very poor

we use pion nucleon scattering data with statistics generated according to expected KLF data for 20 and 100 days to show PWA sensitivity to obtain results close to the best fit

Using πp Scattering surrogate

Cross Section

Recoil polarization

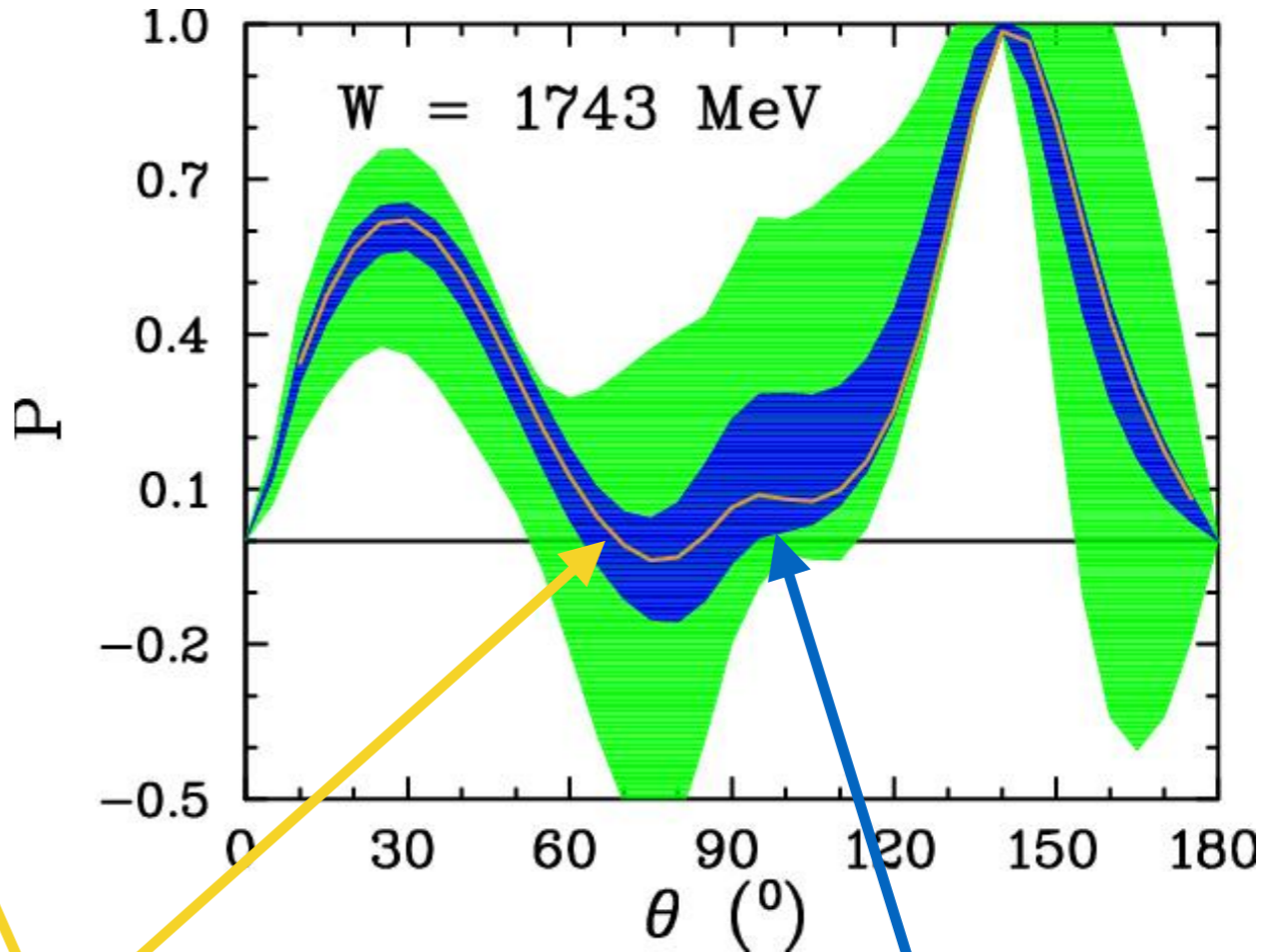
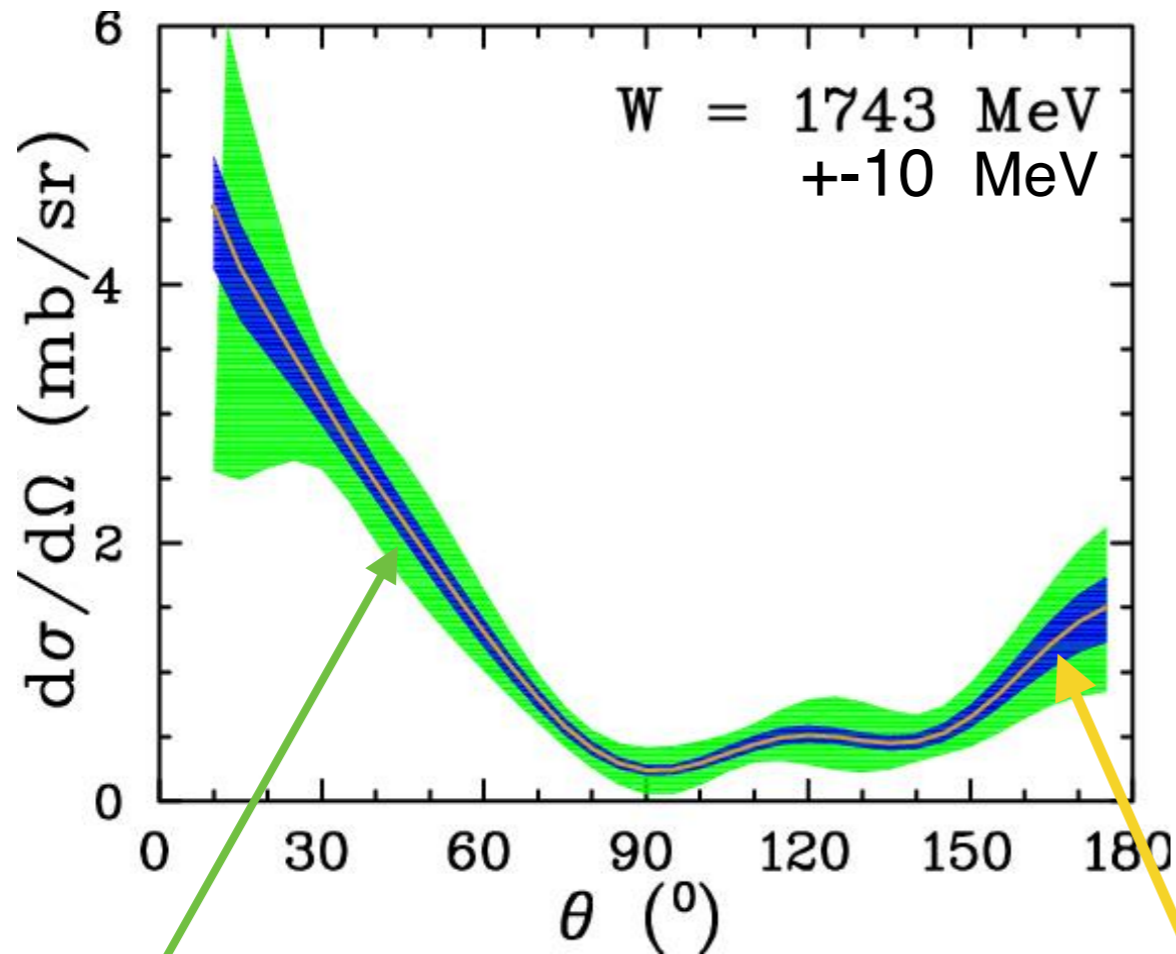

20 days running

SAID Solution

100 days running

Statistics was generated according to KLF for

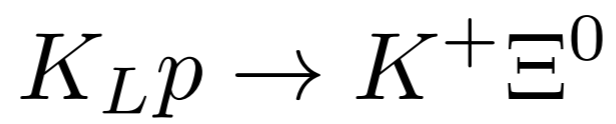

Obviously: we need **at least 100 days** to get unique solution

Strange Meson Spectroscopy

$K\pi$ Scattering

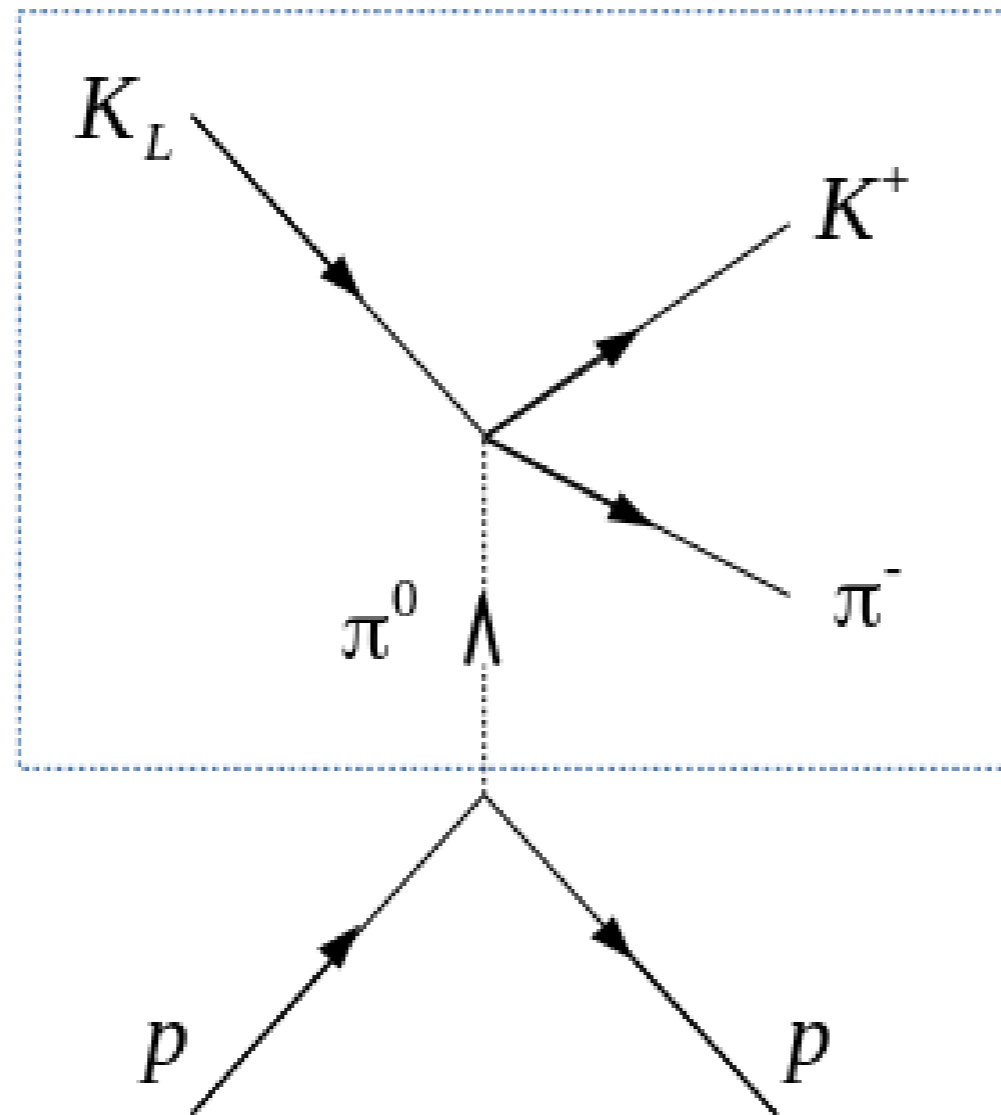

Proposed Measurements

SLAC

$$K^- \pi^+ \rightarrow K^- \pi^+$$

Belle

$$\tau \rightarrow K \pi \nu_\tau$$

KLF

$$K_L \pi^0 \rightarrow K^+ \pi^-$$

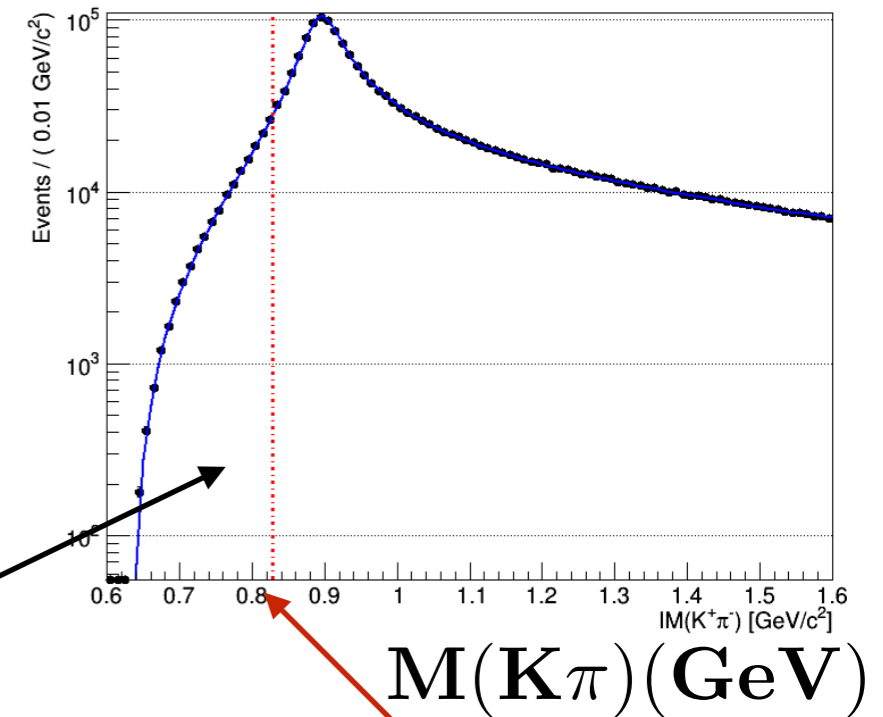
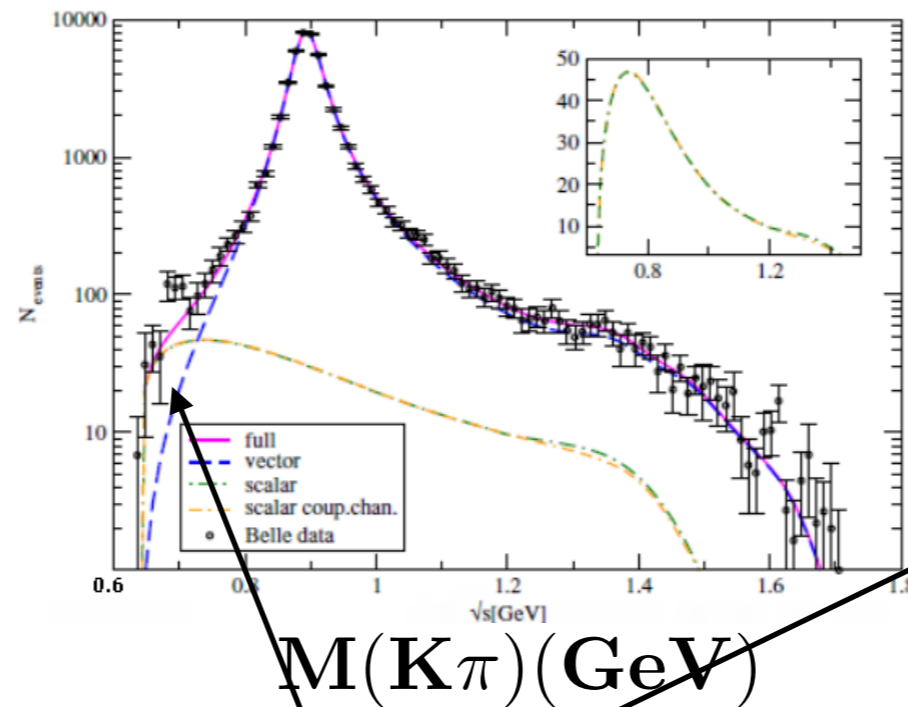
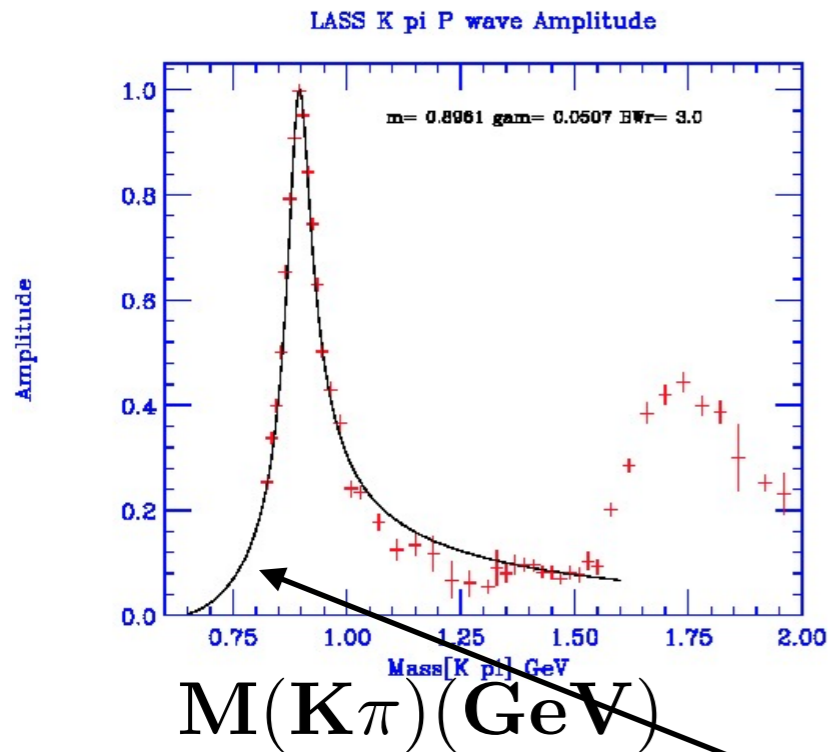

region of $\mathcal{K}(800)$

SLAC Lower limit

Proposed Measurement

$I=3/2+1/2$

S -wave

SLAC Data

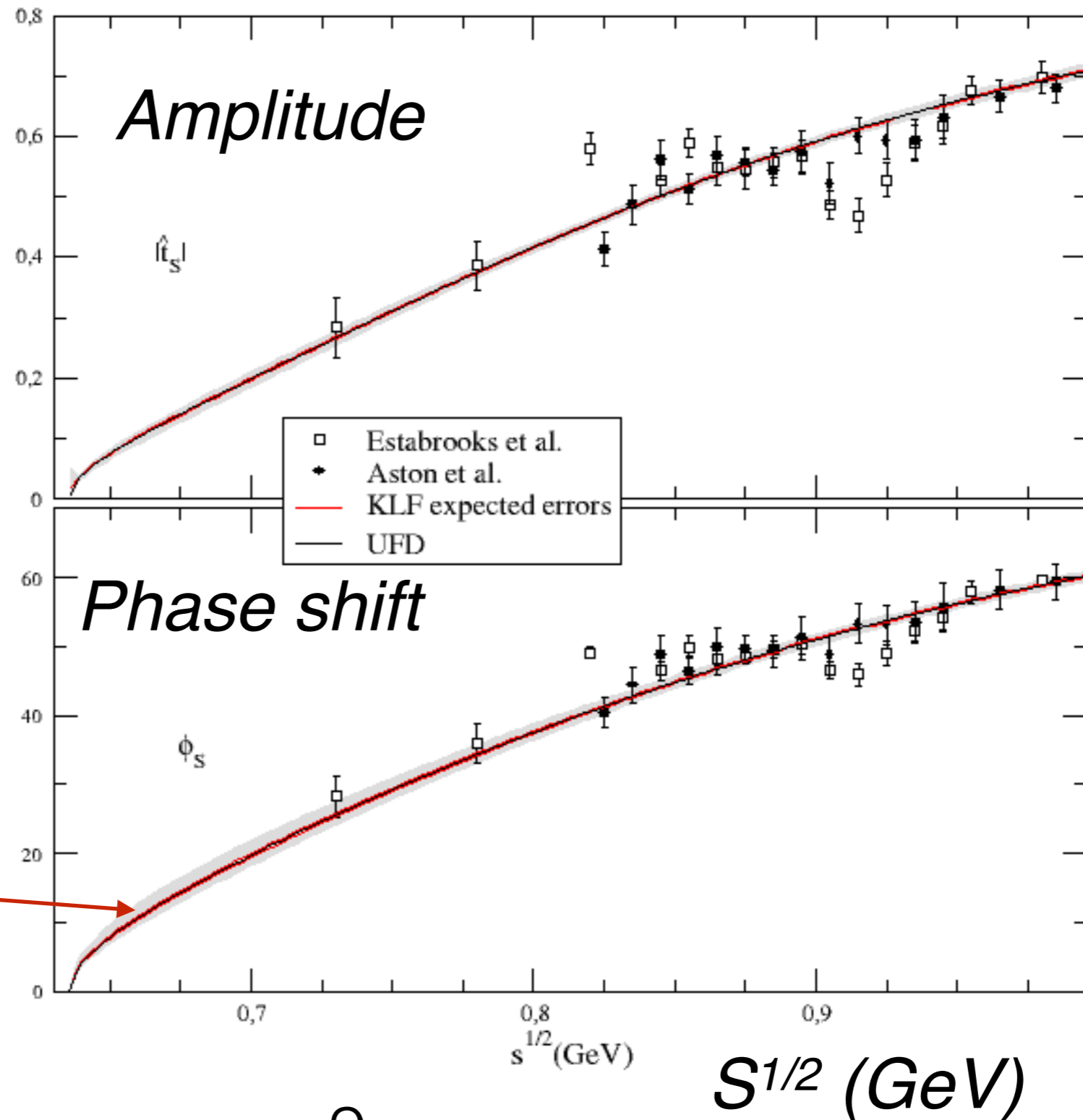

$I=3/2$ S -wave

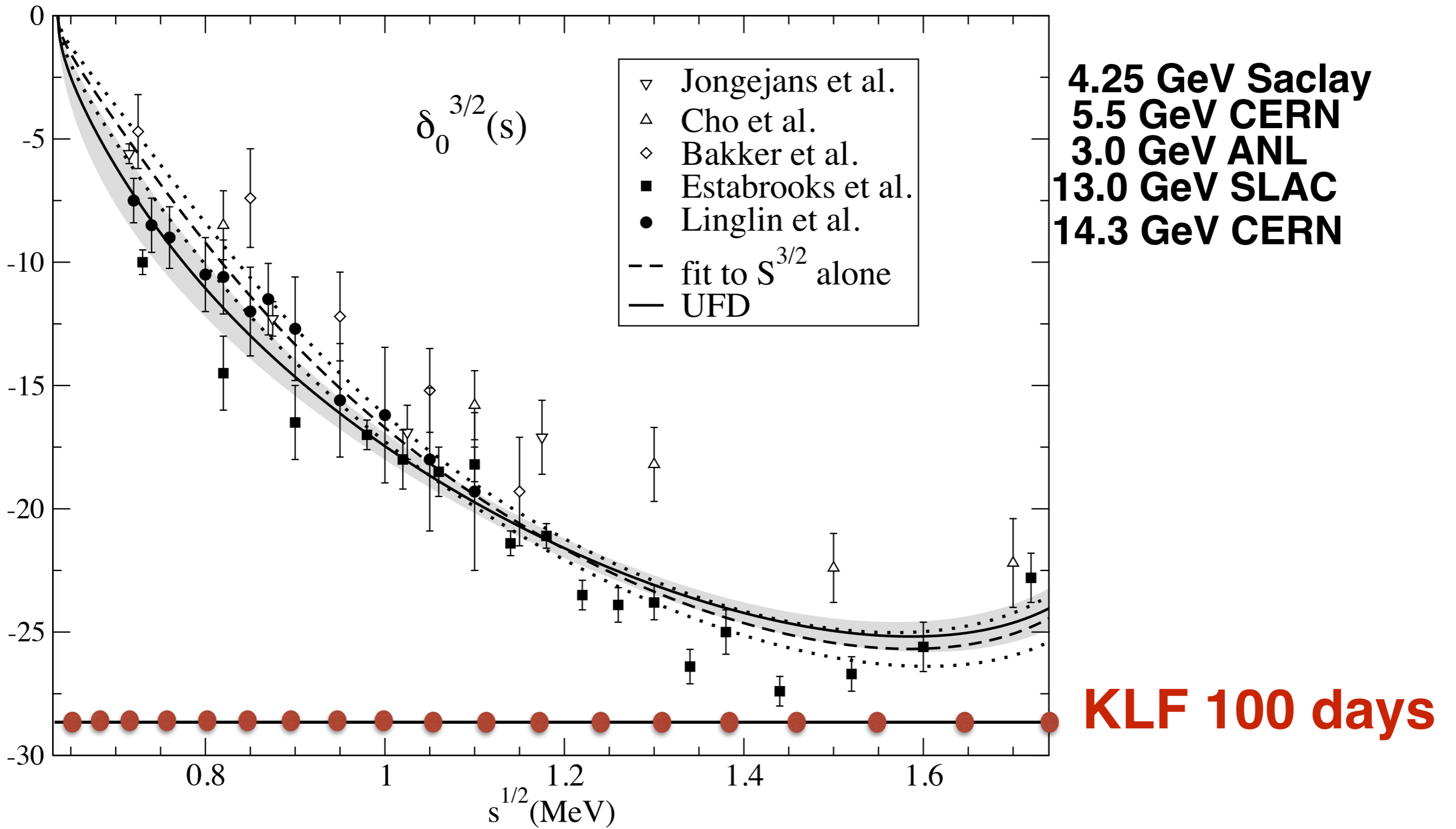

From Pelaez and Rodas paper: PRD93(2016)

Scalar Meson Nonet

$$J^{PC} = 0^{++}$$

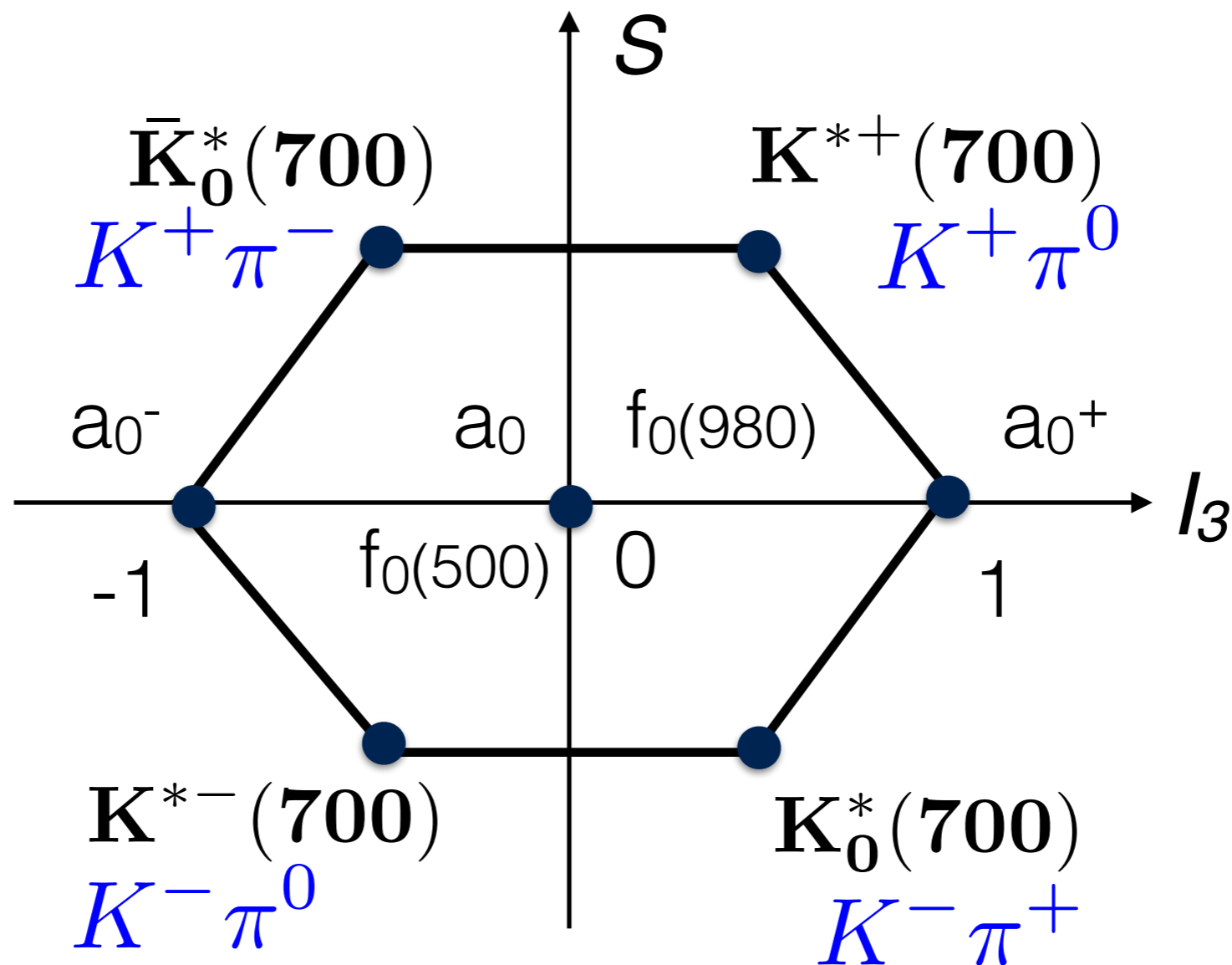

Four states called κ

still need further confirmation(PDG)

We can measure all of them

Measurement of $\kappa(800)$

100 days of running

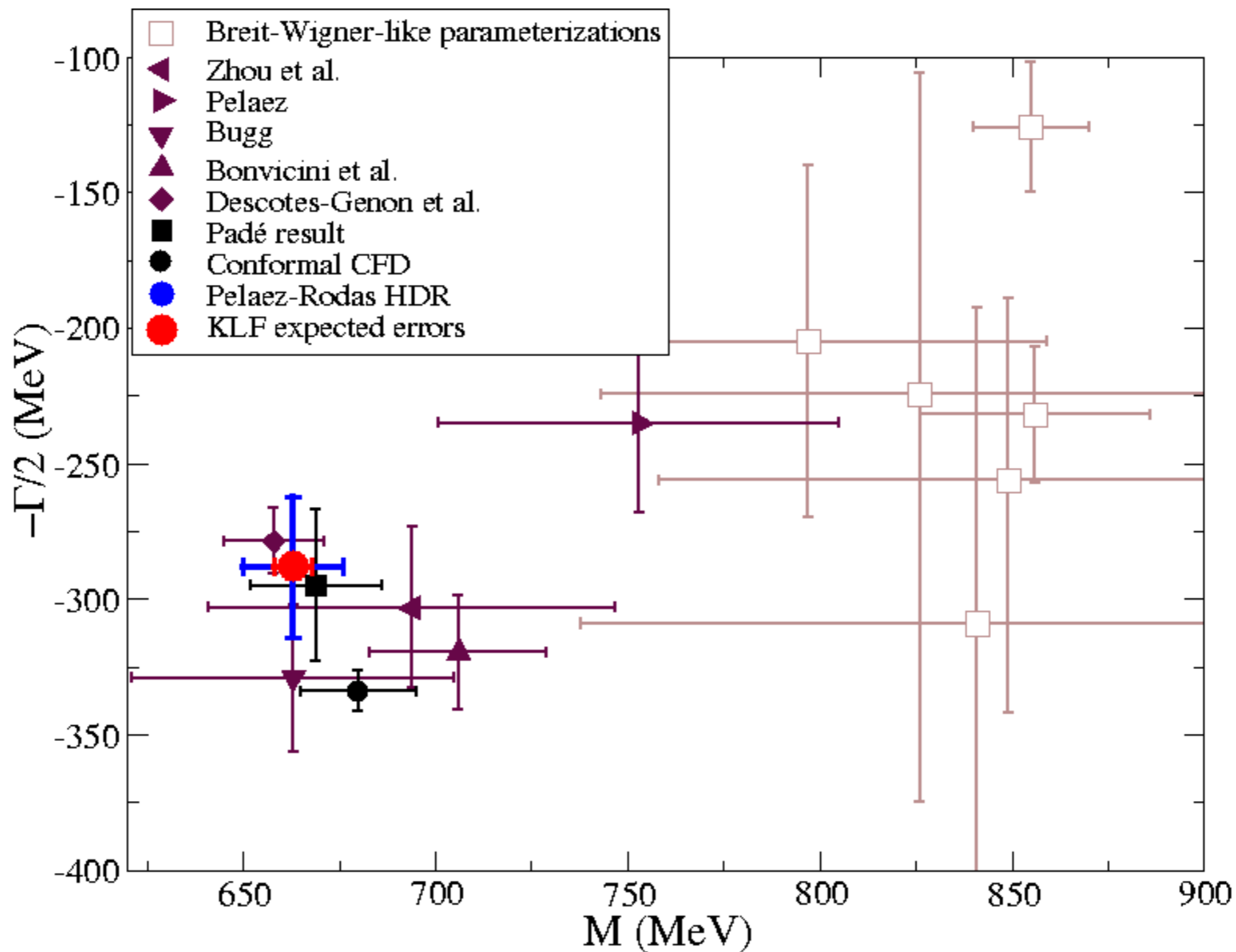

Hall-D beamline and GlueX Setup

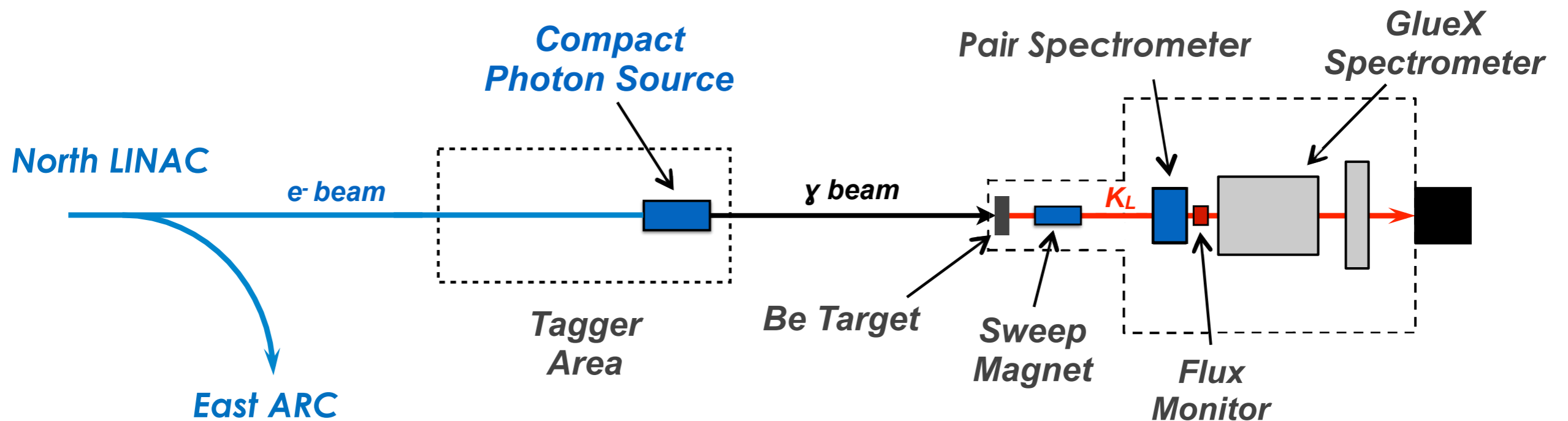

Electron Beam Parameters

$$E_e = 12 \text{ GeV} \quad I = 5 \mu\text{A}$$

$$\text{Bunch spacing} \quad 64 \text{ ns}$$

No major problems.

Doable !

Confirmed by accelerator experts

Estimated investment ~\$100 K for injector upgrade

Compact Photon Source

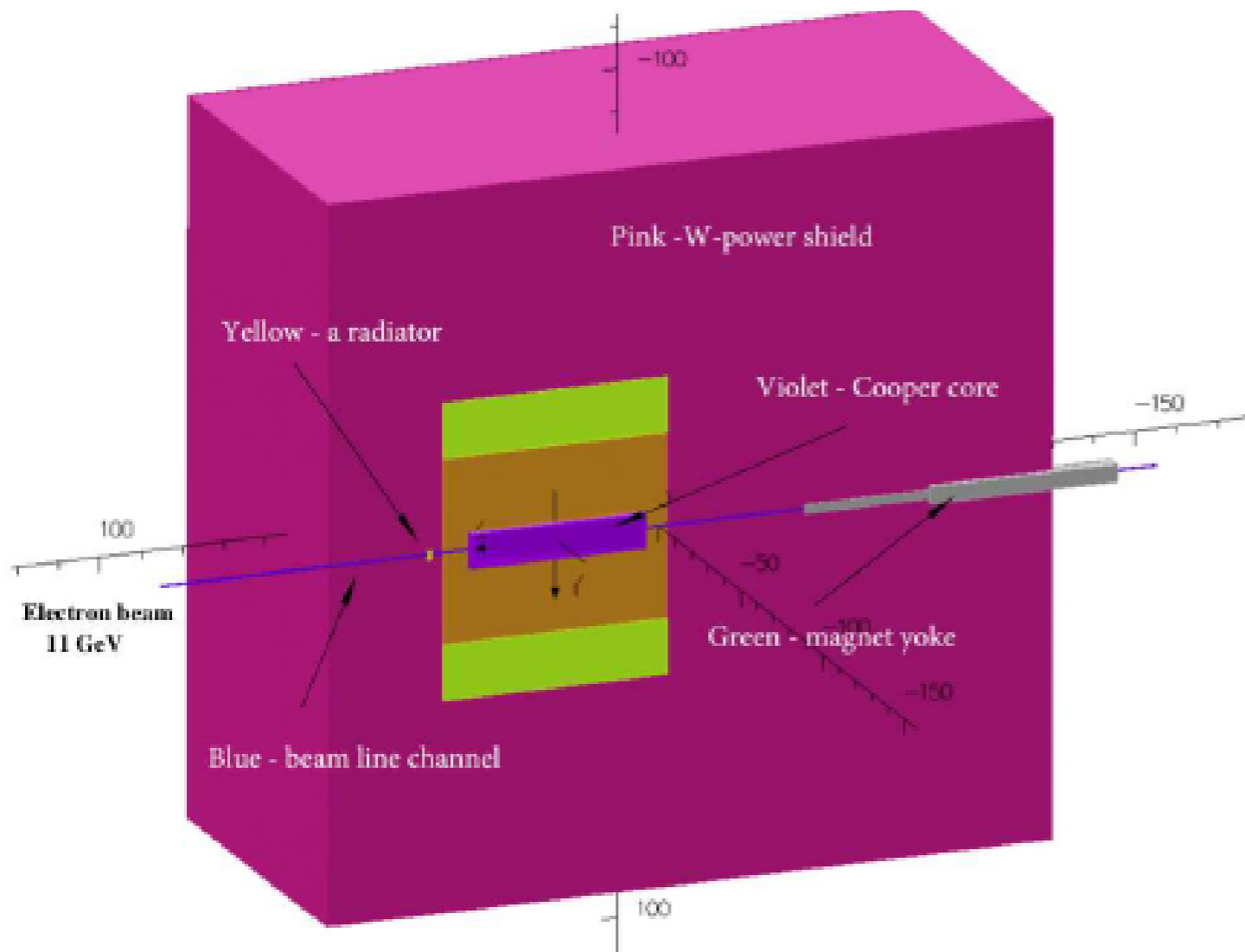

Conceptual design is completed for Halls C/A for $I = 2.7 \mu A$

Could be extended for $I = 5 \mu A$ in Hall D

The details of the CPS are designed by the CPS Collaboration

Meets RadCon Radiation Requirements

Estimated cost ~\$4.0 M

Be Target Assembly: Conceptual Design

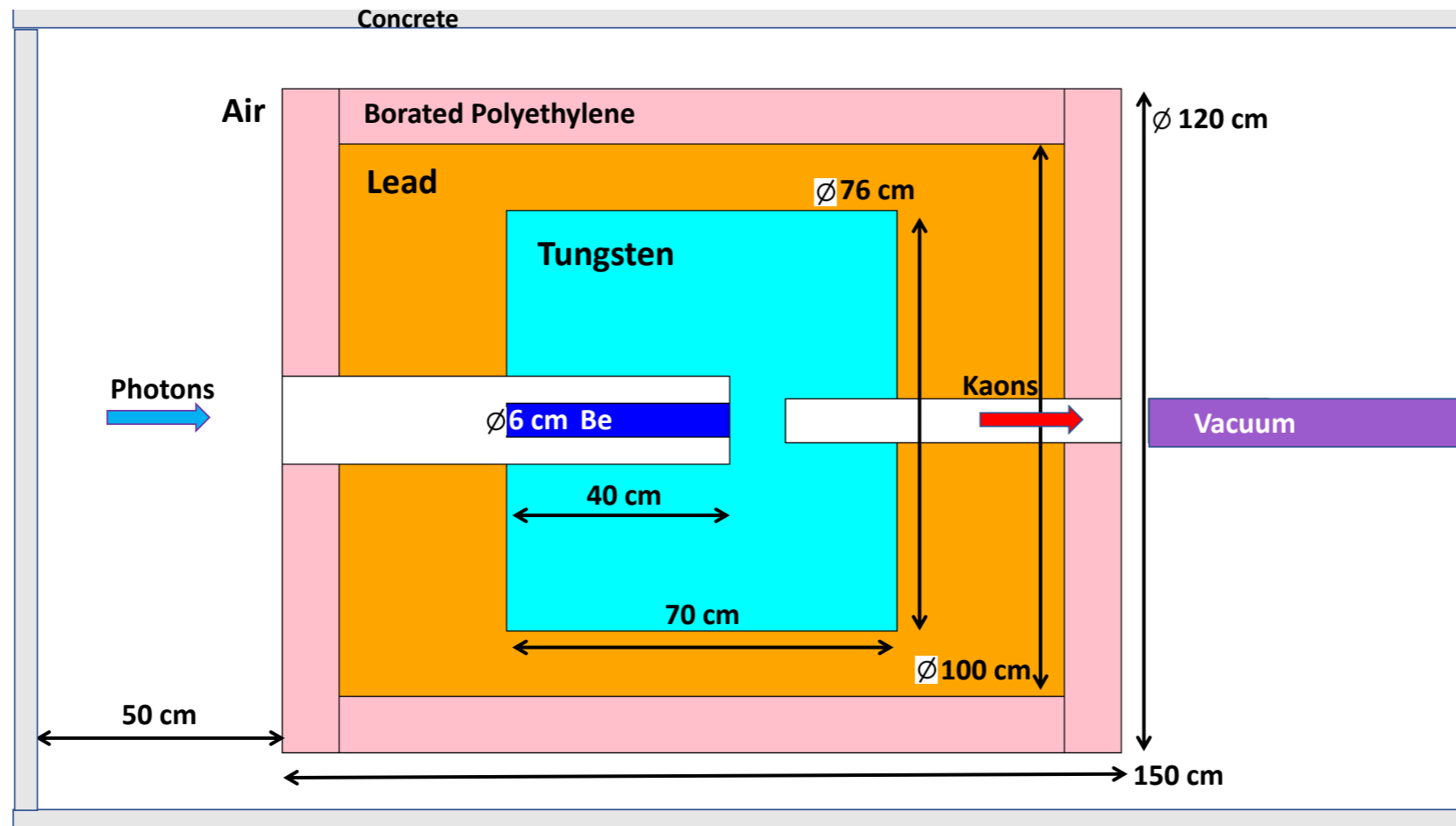

-Meets RadCon Radiation Requirements

-Conceptual Design Endorsed by Hall-D Engineering Staff (Tim Whitlatch)

Estimated cost ~\$1.2 M

Flux Monitor

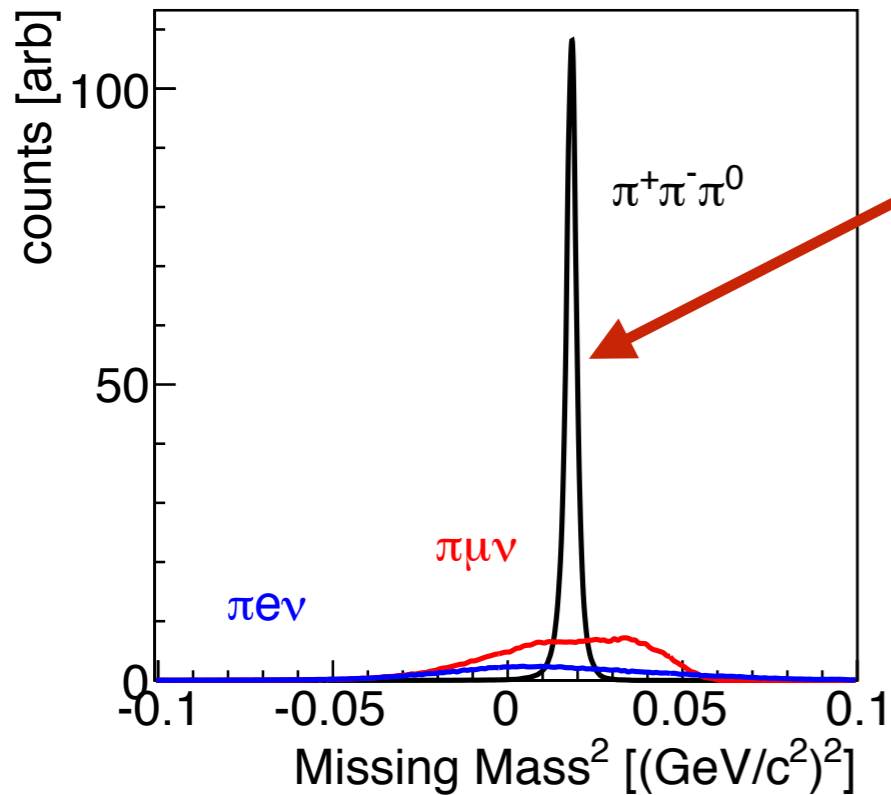
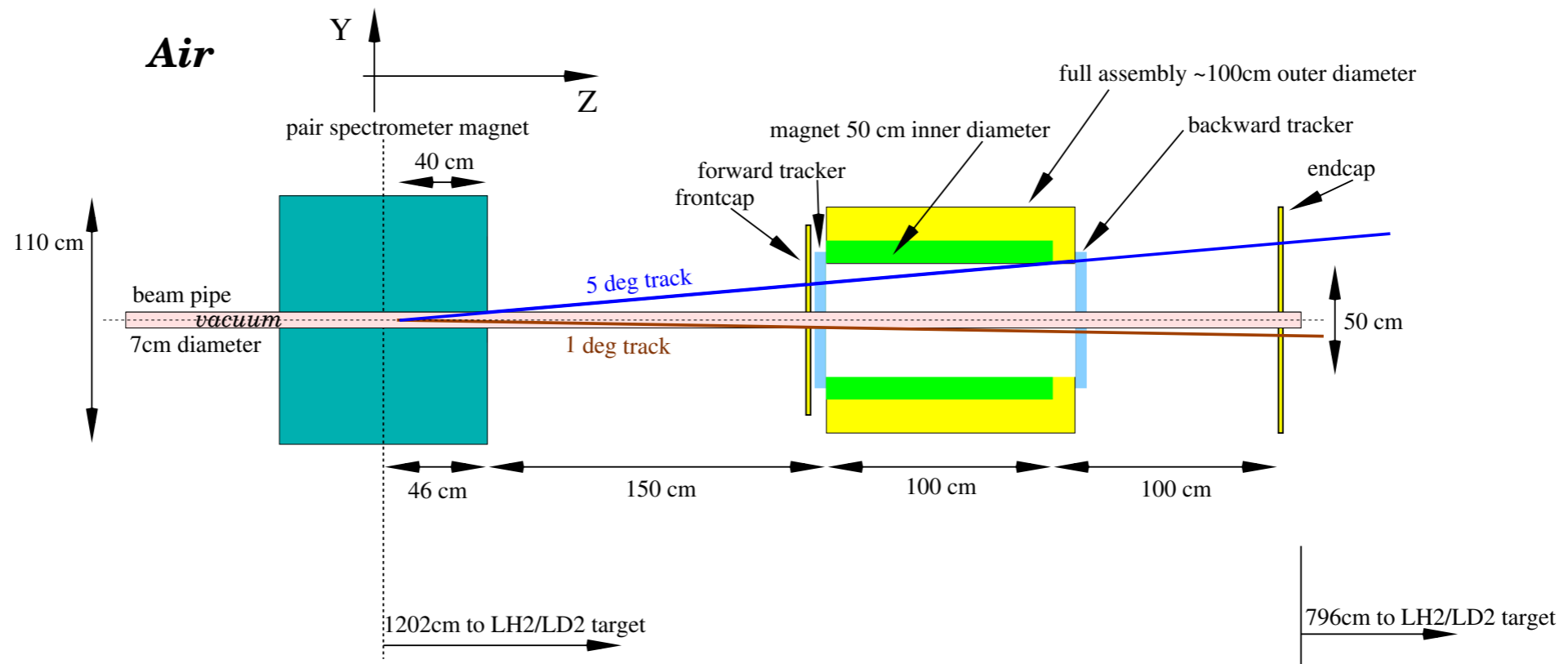

Reconstructed K_L mass

Flux measurement stat. err. <1%

Estimated syst. err. ~5%

Pursuing UK funding

Estimated cost ~\$ 1.0 M

K_L Beam Flux

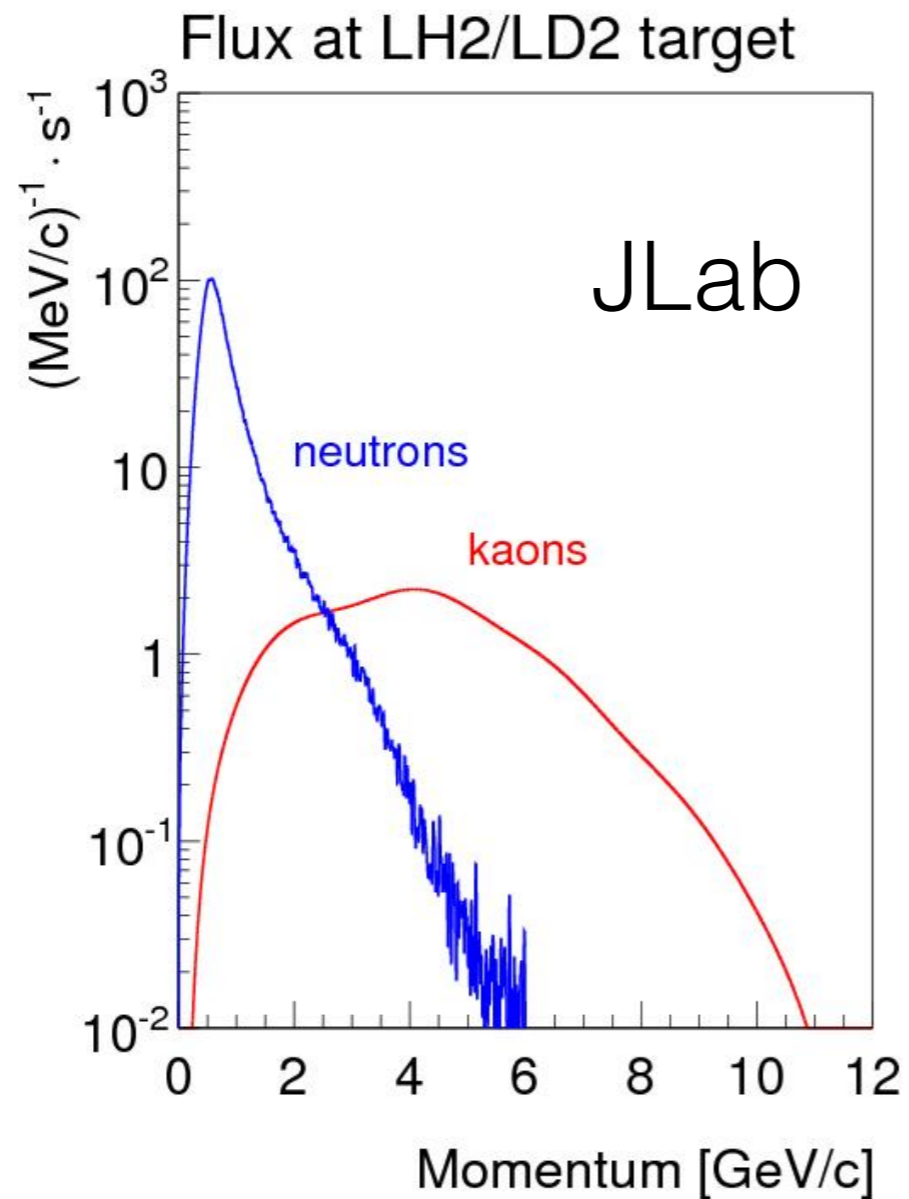

$$N(K_L)/sec \sim 10^4$$

SLAC

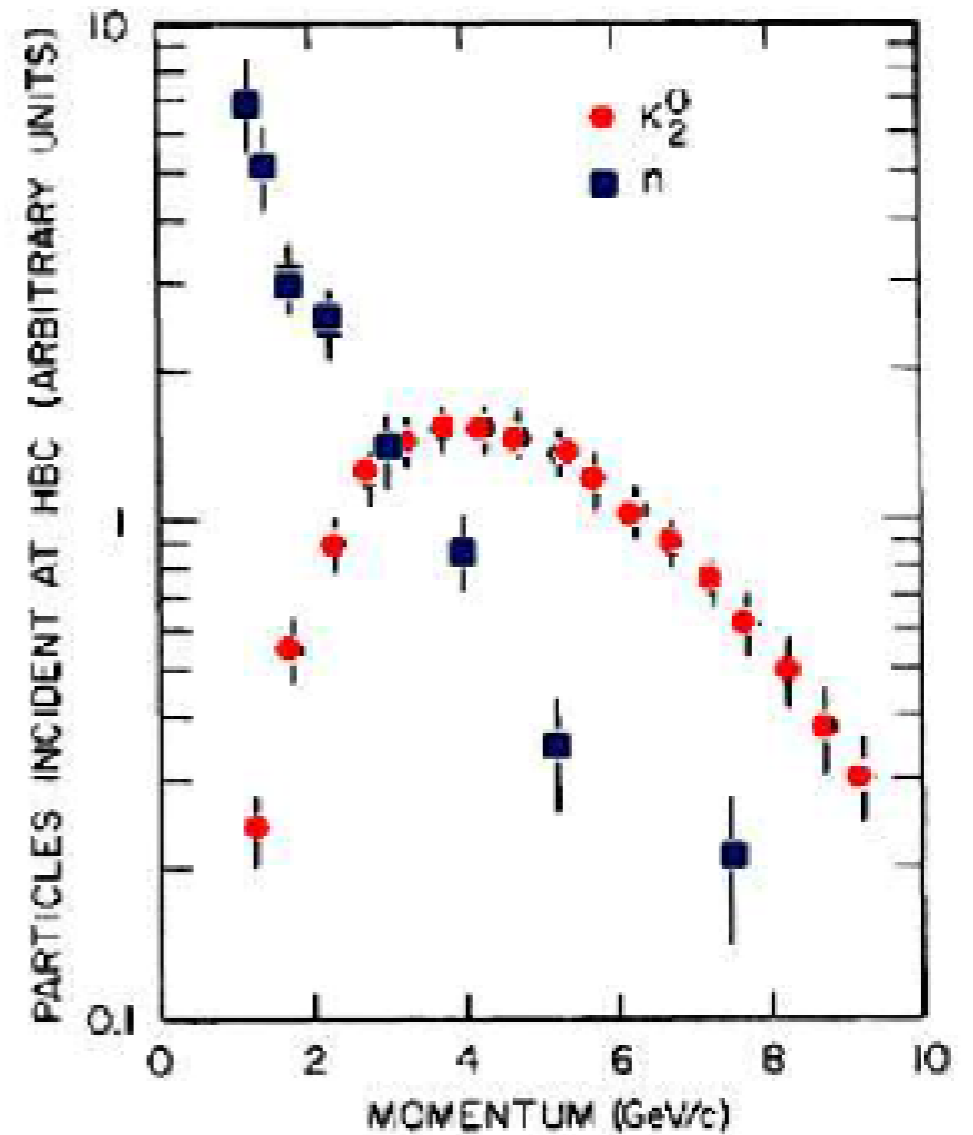

$$\frac{N(K_L)_{JLAB}}{N(K_L)_{SLAC}} \sim 10^3$$

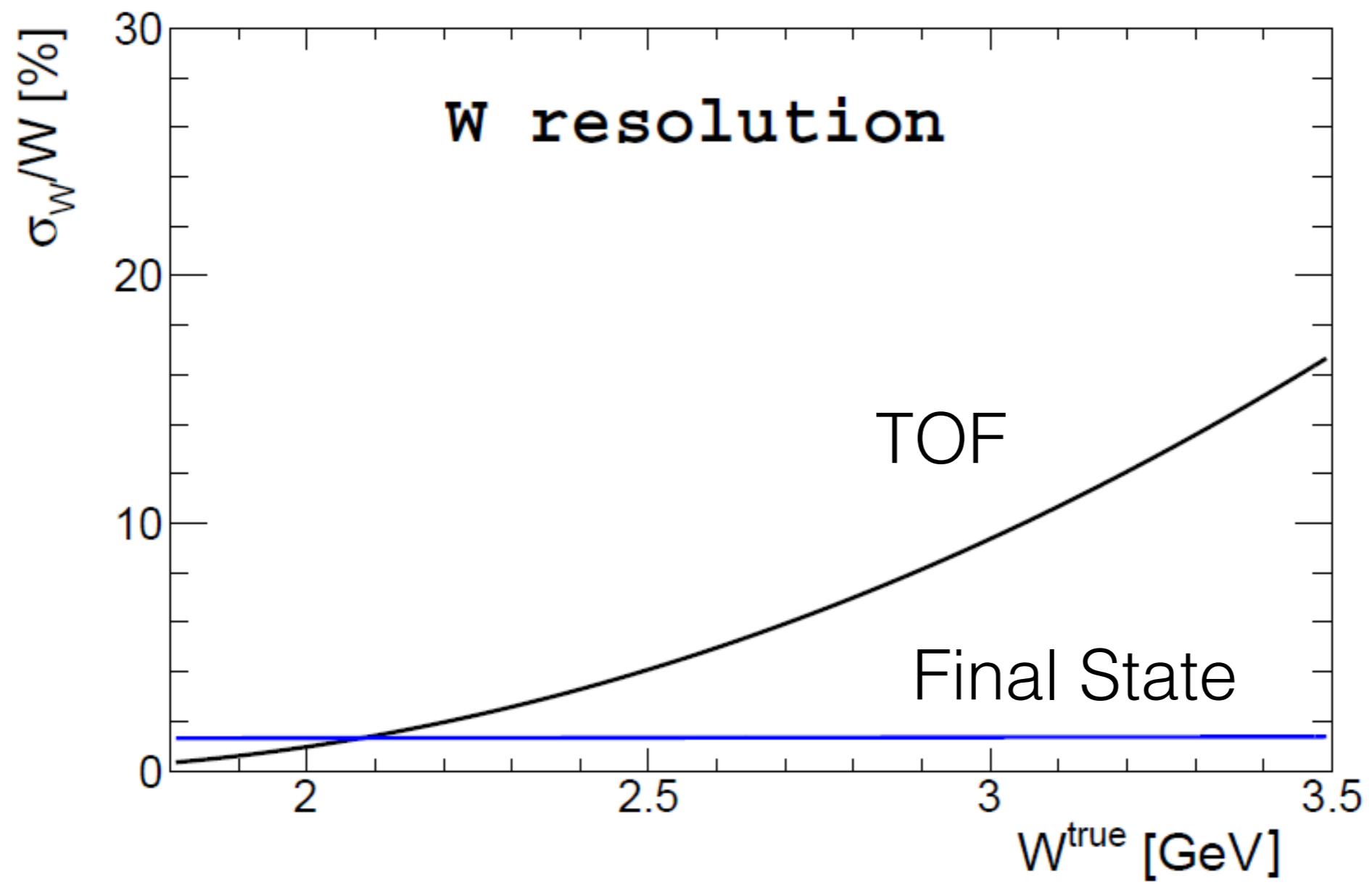

LH₂/LD₂ Cryogenic Target for Neutral Kaon Beam at Hall D

The GlueX liquid hydrogen target.

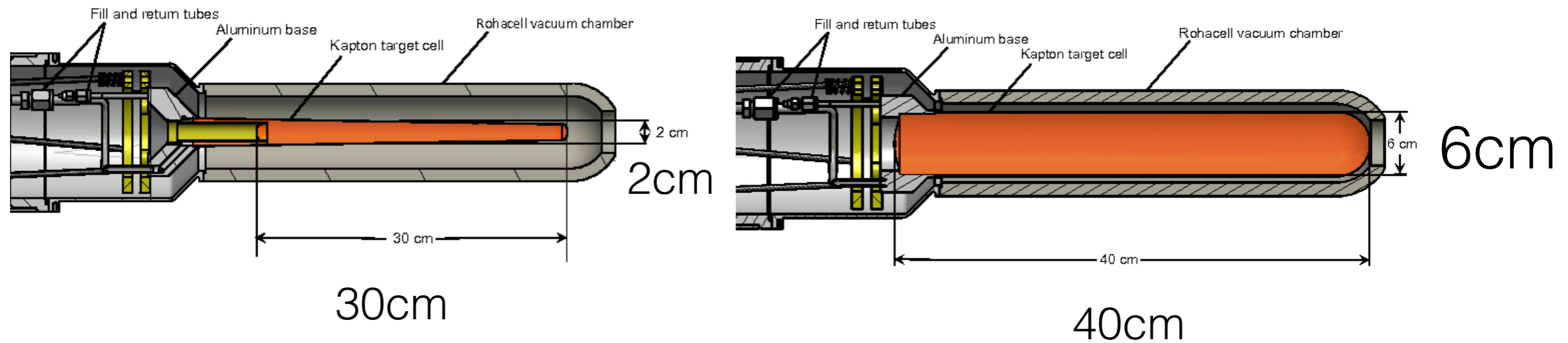

Current

Proposed & Feasible

Longer and thicker target is needed to enhance production rate

Conceptual design endorsed by target group (Chris Keith)

Estimated cost ~\$ 30 K

Total cost of KLF ~\$ 7.0 M

$K\pi$ Scattering Resolutions

Four Momentum Resolution for $K_L p \rightarrow K^+ \pi^- p$

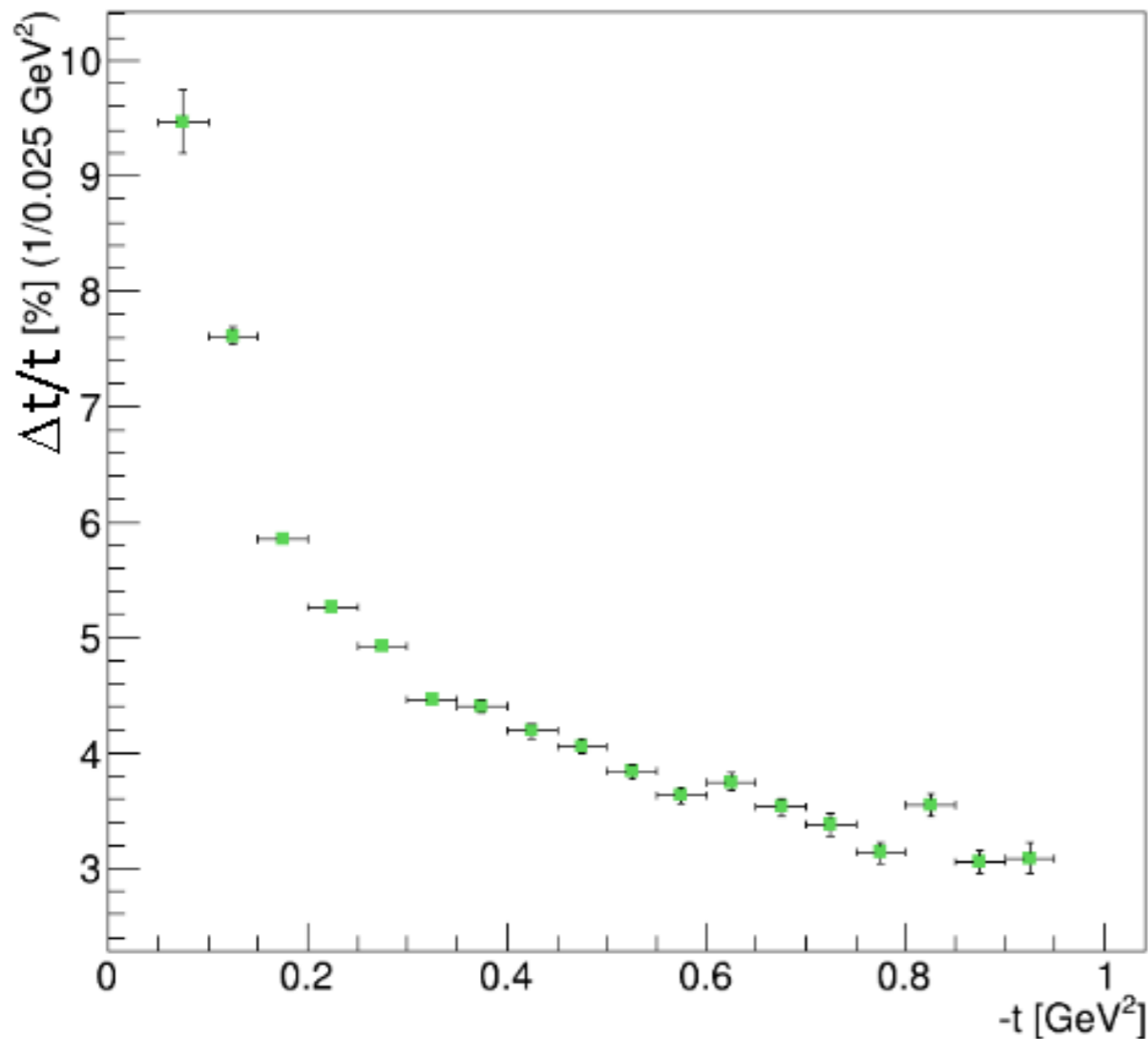

-Good resolution at low- t is needed to be on pion pole

$K^+ \pi^-$ Invariant Mass Resolution for $K_L p \rightarrow K^+ \pi^- p$

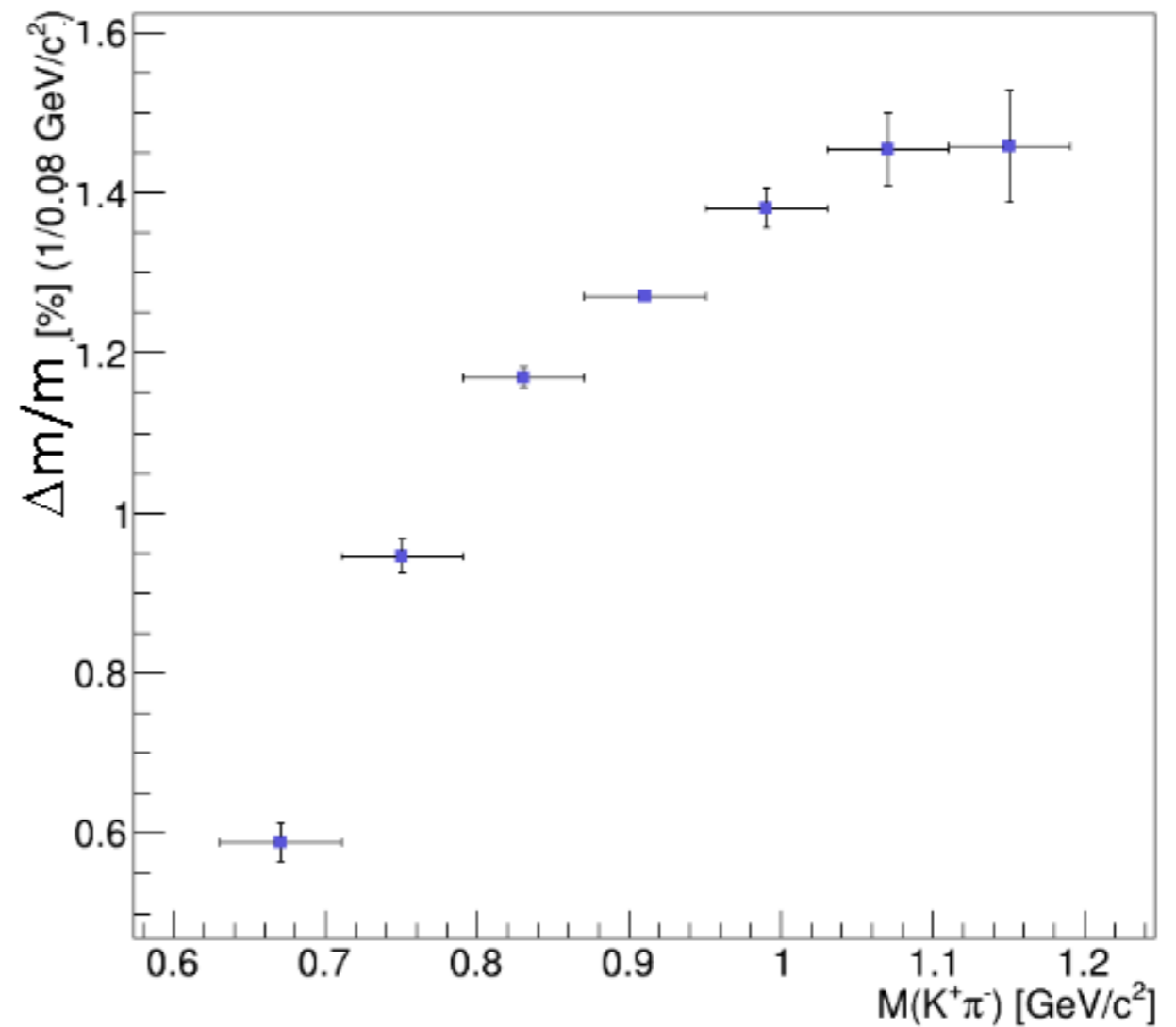

-Binning in $\sim 10 \text{ MeV}$ will cover almost entire elastic K - π scattering range

PHYSICS WITH NEUTRAL KAON BEAM AT JLAB KL2016

FEBRUARY 1-3, 2016
JEFFERSON LAB
NEWPORT NEWS, VIRGINIA

SCOPE

The Workshop is following L012-15-001 "Physics Opportunities with Secondary KL beam at JLab" and will be dedicated to the physics of hyperons produced by the kaon beam on unpolarized and polarized targets with GlueX set up in Hall D. The emphasis will be on the hyperon spectroscopy. Such studies could contribute to the existing scientific program on hadron spectroscopy at Jefferson Lab.

The Workshop will also aim at boosting the international collaboration, in particular between the US and EU research institutions and universities.

The Workshop would help to address the comments made by the PAC43, and to prepare the full proposal for the next PAC44.

ORGANIZING COMMITTEE

Moskov Amaryan, ODU, chair
Eugene Chudakov, JLab
Curtis Meyer, CMU
Michael Pennington, JLab
James Ritman, Ruhr-Uni-Bochum & IKP Jülich
Igor Strakovsky, GWU

WWW.JLAB.ORG/CONFERENCES/KL2016



YSTAR 2016

Excited Hyperons in QCD
Thermodynamics at Freeze-Out

NOVEMBER 16-17, 2016

Jefferson Lab
Newport News, Virginia

A workshop to discuss the influence of possible "missing" hyperon resonances (JLab KLF Project) on QCD thermodynamics, on freeze-out in heavy ion collisions and in the early universe, and in spectroscopy. Recent studies that compare lattice QCD calculations of thermodynamic calculations, statistical hadron resonance gas models, and ratios between measured yields of different hadron species in heavy ion collisions provide indirect evidence for the presence of "missing" resonances in all of these contexts. The aim of the workshop is to sharpen these comparisons, advance our understanding of the formation of baryons from quarks and gluons microseconds after the Big Bang and in today's experiments, and to connect these developments to experimental searches for direct, spectroscopic, evidence for these resonances. This Workshop is a successor to the recent KL2016 Workshop

ORGANIZING COMMITTEE

Moskov Amaryan - Chair, ODU
Eugene Chudakov, JLab
Krishna Rajagopal, MIT
Chandia Ratti, University of Houston
James Ritman, Ruhr U. Bochum & IKP Jülich
Igor Strakovsky, GWU



WWW.JLAB.ORG/CONFERENCES/YSTAR2016/



HIPS 2017

New Opportunities with High-Intensity Photon Sources

February 6-7, 2017
Catholic University of America
Washington, DC U.S.A.

This workshop aims at producing an optimized photon source concept with potential increase of scientific output at Jefferson Lab, and at refining the science for hadron physics experiments benefiting from such a high-intensity photon source. The workshop is dedicated to bringing together the communities directly using such sources for photo-production experiments, or for conversion into K_s beams. The combination of high precision calorimetry and high intensity photon sources can provide greatly enhanced scientific benefit to (deep) exclusive processes like wide-angle and time-like Compton scattering. Potential prospects of such a high-intensity source with modern polarized targets will also be discussed. The availability of K_s beams would open new avenues for hadron spectroscopy, for example for the investigations of "missing" hyperon resonances, with potential impact on QCD thermodynamics and on freeze-out both in heavy ion collisions and the early universe.

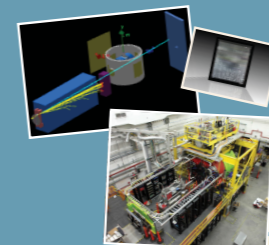

Organizing Committee:

Tanja Horn - CUA
Cynthia Keppel - JLab
Carlos Munoz-Camacho - IPNO
Igor Strakovsky - GWU



π -K Interactions Workshop

ORGANIZING COMMITTEE

Moskov Amaryan, ODU (Chair)
U.G. Meissner, U. Bonn/FZ Jülich
Curtis Meyer, CMU
James Ritman, Ruhr-Uni-Bochum/FZ Jülich
Igor Strakovsky, GWU

February 14-15, 2018

Jefferson Lab • Newport News, VA

The π -K scattering enables direct investigations of scalar and vector K^* states, including the not yet established S-wave $k(800)$ state. These studies are also needed to get precise values of vector and scalar form factors: to independently extract CKM matrix element V_{us} and to test the Standard Model unitarity relation in the first row of CKM matrix, to study CP violation from the Dalitz plot analysis of open charm D meson decays and in a charmless decays of B mesons in Kpipi final states. Significant progress is made lately in Lattice QCD, in the phenomenology and in the Chiral Perturbation Theory to describe different aspects of π -K scattering. The main source of experimental data is based on experiments performed in SLAC almost five decades ago at 1970-80s. The recently proposed KL Facility incorporating the GlueX spectrometer at JLab will be able to improve the π -K scattering database by about three orders of magnitude in statistics. The workshop will discuss the necessity for and the impact of the future high statistics data obtained at JLab on π -K scattering.

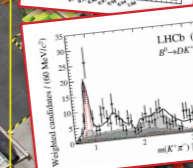
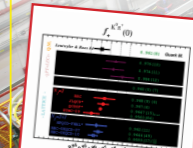
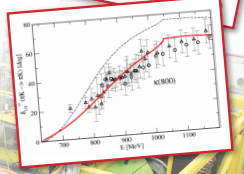
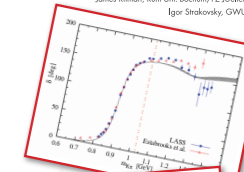

<https://www.jlab.org/conferences/pki2018/>



KL2016

[60 people from 10 countries, 30 talks] <https://www.jlab.org/conferences/kl2016/>

OC: M. Amaryan, E. Chudakov, C. Meyer, M. Pennington, J. Ritman, & I. Strakovsky

YSTAR2016

[71 people from 11 countries, 27 talks] <https://www.jlab.org/conferences/YSTAR2016/>

OC: M. Amaryan, E. Chudakov, K. Rajagopal, C. Ratti, J. Ritman, & I. Strakovsky

HIPS2017

[43 people from 4 countries, 19 talks] <https://www.jlab.org/conferences/HIPS2017/>

OC: T. Horn, C. Keppel, C. Munoz-Camacho, & I. Strakovsky

PKI2018

[48 people from 9 countries, 27 talks] <http://www.jlab.org/conferences/pki2018/>

OC: M. Amaryan, U.-G. Meissner, C. Meyer, J. Ritman, & I. Strakovsky

In total: 222 participants & 103 talks

Proposal:
200 Members
61 Institutions
20 Countries

A. Ali¹⁸, M. B. Ali⁴⁷, M. J. Amaryan^{45,*†}, E. G. Anassontzis², A. V. Anisovich^{4,48},
A. Austregesilo³⁰, M. Baalouch⁴⁵, F. Barbosa³⁰, J. Barlow¹³, A. Barnes⁷, E. Barriga¹³,
M. Bashkanov^{10,†}, A. Bazavov³⁹, T. D. Beattie⁵⁰, R. Bellwied²⁰, V. V. Berdnikov⁸, V. Bernard⁴⁶,
T. Black⁴², W. Boeglin¹², M. Boer⁸, W. J. Briscoe¹⁴, T. Britton³⁰, W. K. Brooks⁵³, B. E. Cannon¹³,
N. Cao²², E. Chudakov³⁰, G. Colangelo³, P. L. Cole²¹, S. Cole¹, O. Cortes-Becerra¹⁴, V. Crede¹³,
M. M. Dalton³⁰, T. Daniels⁴², D. Day⁵⁸, P. Degtyarenko³⁰, A. Deur³⁰, S. Dobbs¹³, G. Dodge⁴⁵,
A. G. Dolgolenko²⁷, M. Döring^{14,30}, M. Dugger¹, R. Dzhygadlo¹⁸, S. Eidelman^{5,44}, R. Edwards³⁰,
H. Egiyan³⁰, A. Ernst¹³, A. Eskandarian¹⁴, P. Eugenio¹³, C. Fanelli³⁶, S. Fegan¹⁴, A. Filippi²⁵,
A. M. Foda⁵⁰, J. Frye²³, S. Furletov³⁰, L. Gan⁴², A. Gasparyan⁴¹, G. Gavalian³⁰,
M. Gauzshtein^{54,55}, N. Gevorgyan⁶¹, C. Gleason²³, D. I. Glazier¹⁷, J. Goity^{30,19},
V. S. Goryachev²⁷, K. Götzen¹⁸, A. Goncalves¹³, L. Guo¹², H. Haberzettl¹⁴,
M. Hadžimehmedović⁵⁷, H. Hakobyan⁵³, A. Hamdi¹⁸, S. Han⁶⁰, J. Hardin³⁶, A. Hayrapetyan¹⁶,
G. M. Huber⁵⁰, A. Hurley⁵⁹, C. E. Hyde⁴⁵, T. Horn⁸, D. G. Ireland¹⁷, M. Ito³⁰, R. Jaffe³⁶,
N. Jarvis⁷, R. T. Jones⁹, V. Kakoyan⁶¹, G. Kalicy⁸, M. Kamel¹², C. D. Keith³⁰, C. W. Kim¹⁴,
F. J. Klein¹⁴, B. Z. Kopeliovich⁵³, C. Kourkoumeli², G. Krafft³⁰, S. Kuleshov⁵³, I. Kuznetsov^{54,55},
A. B. Laptev³³, I. Larin³⁵, D. Lawrence³⁰, D. I. Lersch¹³, H. Leutwyler³, M. Levillain⁴¹, H. Li⁷,
W. Li⁵⁹, K. Livingston¹⁷, B. Liu²², G. J. Lolos⁵⁰, V. E. Lyubovitskij^{56,54,55,53}, D. Mack³⁰,
M. Mai¹⁴, D. M. Manley³¹, M. Mazouz⁴⁷, H. Marukyan⁶¹, V. Mathieu³⁰, M. Matveev⁴⁸,
V. Matveev²⁷, M. McCaughan³⁰, W. McGinley⁷, M. McCracken⁷, J. McIntyre⁹,
U.-G. Meißner^{4,29}, C. A. Meyer⁷, R. Miskimen³⁵, R. E. Mitchell²³, F. Mokaya⁹, V. Mokeev³⁰,
C. Morningstar⁷, B. Moussallam⁴⁶, F. Nerling¹⁸, K. Nakayama¹⁵, Y. Oh³², R. Omerović⁵⁷,
H. Osmanović⁵⁷, A. Ostrovidov¹³, Z. Papandreou⁵⁰, K. Park³⁰, E. Pasyuk³⁰, M. Patsyuk³⁶,
P. Pauli¹⁷, R. Pedroni⁴¹, J. R. Pelaez³⁴, L. Pentchev³⁰, K. J. Peters¹⁸, W. Phelps¹⁴, A. Pilloni³⁰,
E. Pooser³⁰, J. W. Price⁶, N. Qin⁴³, J. Reinhold¹², D. Richards³⁰, D.-O. Riska¹¹, B. Ritchie¹,
J. Ritman^{51,28,†}, L. Robison⁴³, A. Rodas³⁴, D. Romanov³⁷, C. Romero⁵³, J. Ruiz de Elvira³,
H-Y. Ryu⁴⁹, C. Salgado⁴⁰, E. Santopinto²⁴, A. V. Sarantsev^{4,48}, T. Satogata³⁰, A. M. Schertz⁵⁹,
R. A. Schumacher⁷, C. Schwarz¹⁸, J. Schwiening¹⁸, A. Yu. Semenov⁵⁰, I. A. Semenova⁵⁰,
K. K. Seth⁴³, X. Shen²², M. R. Shepherd²³, E. S. Smith³⁰, D. I. Sober⁸, D. Sokhan¹⁷, A. Somov³⁰,
S. Somov³⁷, O. Soto⁵³, M. Staib⁷, J. Stahov⁵⁷, J. R. Stevens^{59,†}, I. I. Strakovsky^{14,†}, A. Švarc⁵²,
A. Szczepaniak^{23,30}, V. Tarasov²⁷, S. Taylor³⁰, A. Teymurazyan⁵⁰, A. Trabelsi⁴⁷, G. Vasileiadis²,
D. Watts¹⁰, D. Werthmüller¹⁷, T. Whitlatch³⁰, N. Wickramaarachchi⁴⁵, M. Williams³⁶,
B. Wojtsekhowski³⁰, R. L. Workman¹⁴, T. Xiao⁴³, Y. Yang³⁶, N. Zachariou¹⁰, J. Zarling²³,
J. Zhang⁵⁸, Z. Zhang⁶⁰, G. Zhao²², B. Zou²⁶, Q. Zhou²², X. Zhou⁶⁰, B. Zihlmann³⁰

SUMMARY

- **-Proposed KL Facility has unique capability to improve existing world database up to three orders of magnitude**
- **-In Hyperon spectroscopy**
PWA will allow to measure pole positions and widths of excited hyperon states
- **-In Strange Meson Spectroscopy**
PWA will allow to measure excited K^* states including scalar $f_0(800)$ states
- **To accomplish physics program**
100 days per LH2 and LD2 is required
- **All components of KL Facility considered are feasible**
-With total cost of project ~\$ 7.0 M
including \$1.0 M from UK

Backup

3. $K_L n \rightarrow K^+ \Xi^{*-}$ Reaction

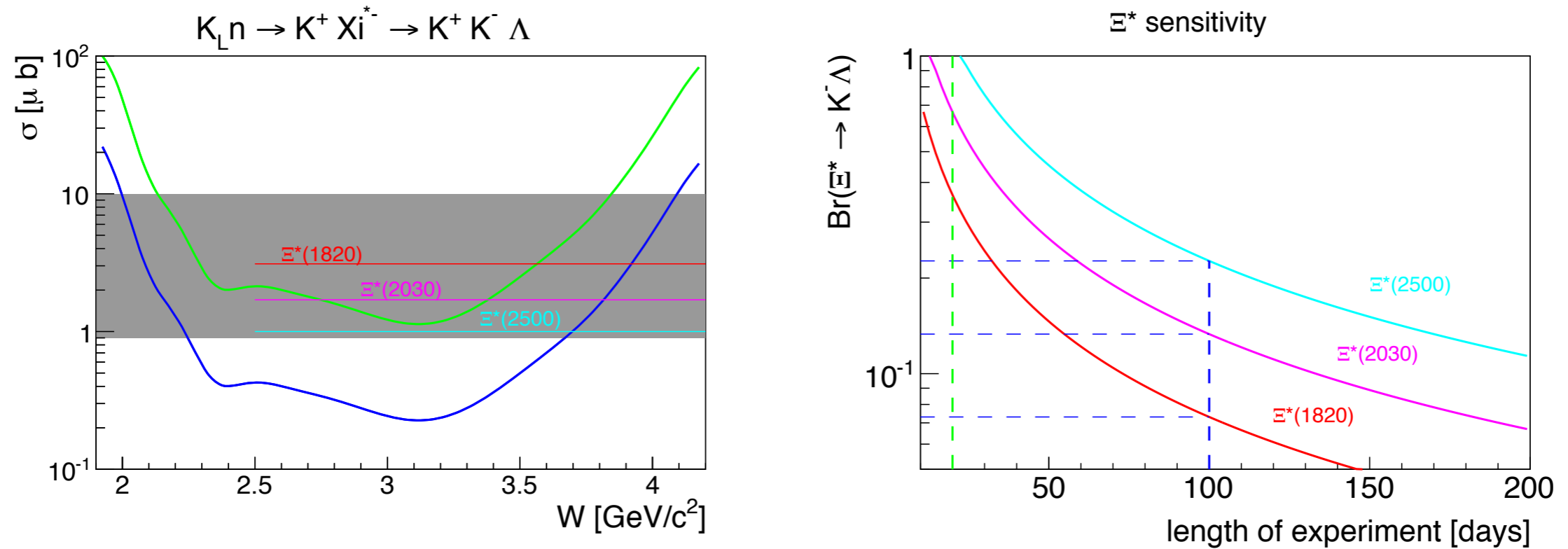

Figure 47: Left panel: The Ξ^* discovery potential achievable at KLF during the 100 (blue) and 20 (green) day experiment, under assumption of 10 % statistical accuracy and $Br(\Xi^* \rightarrow \bar{K} \Lambda) = 1$. The gray band corresponds to typical Ξ^* cross sections and horizontal lines are few examples of BNL cross sections from Ref. [196] Right panel: Estimation of lowest measurable $\Xi^* \rightarrow \bar{K} \Lambda$ branching fraction at KLF as a function of experiment duration at $W \sim 3.1 \pm 0.025$ GeV. Two benchmark cases of 100 (20) days are highlighted by dashed blue (green) curves.